

D2408-L22-X

Steel, DIN 2353 Plug, Light 22mm Tube OD, Body Only

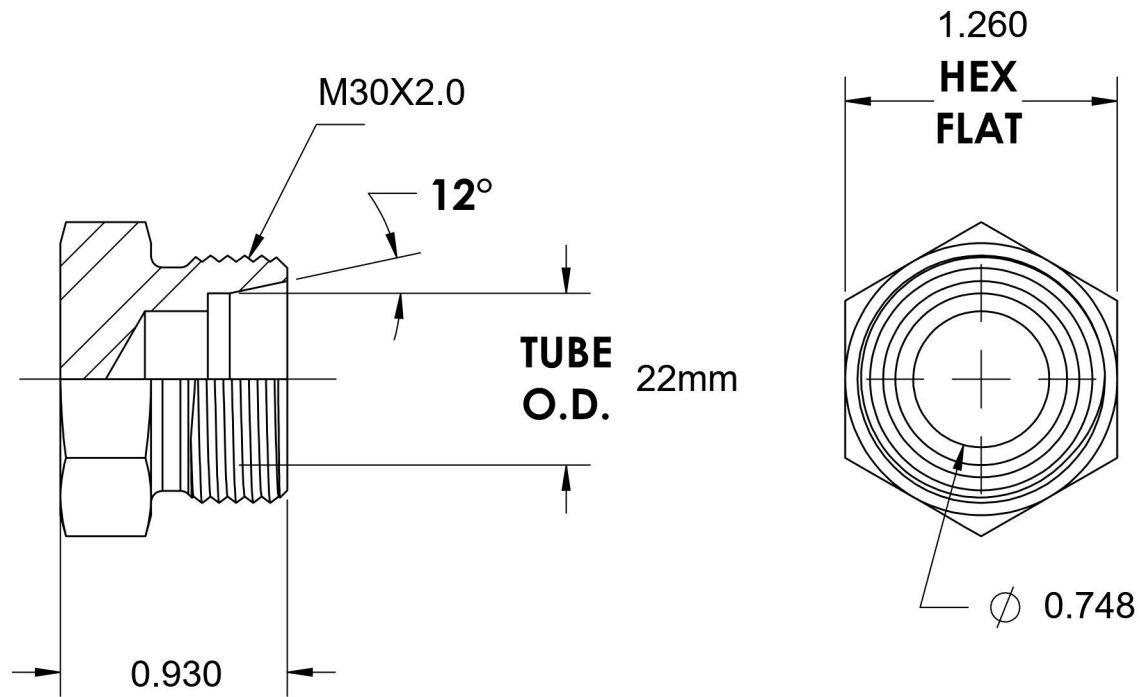
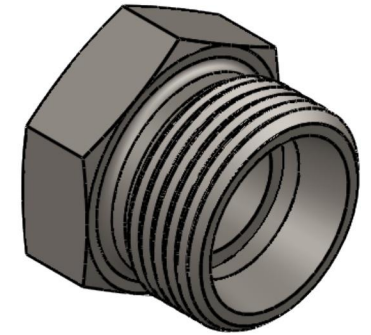

6701 Cochran Road
Solon, Ohio 44139
Phone: (440) 248-1880
Toll Free: 1-888-331-1523

Temperature Rating

-65°F to 500°F

Pressure Rating

3626 psi

Material

C22 Steel

Finish

Zinc Nickel

Industry Standards

DIN 2353, ISO 8434-1

Series

D2408-X

Series Description

DIN 2353 Flareless
Tube Plug, Body Only