

# 6802-06-08-NWO-FG-VITON

Steel, SAE J514 37° Flare 45° Adjustable Port Elbow, 3/8" Male JIC x 3/4-16 Male Adjustable ORB, FKM Seal

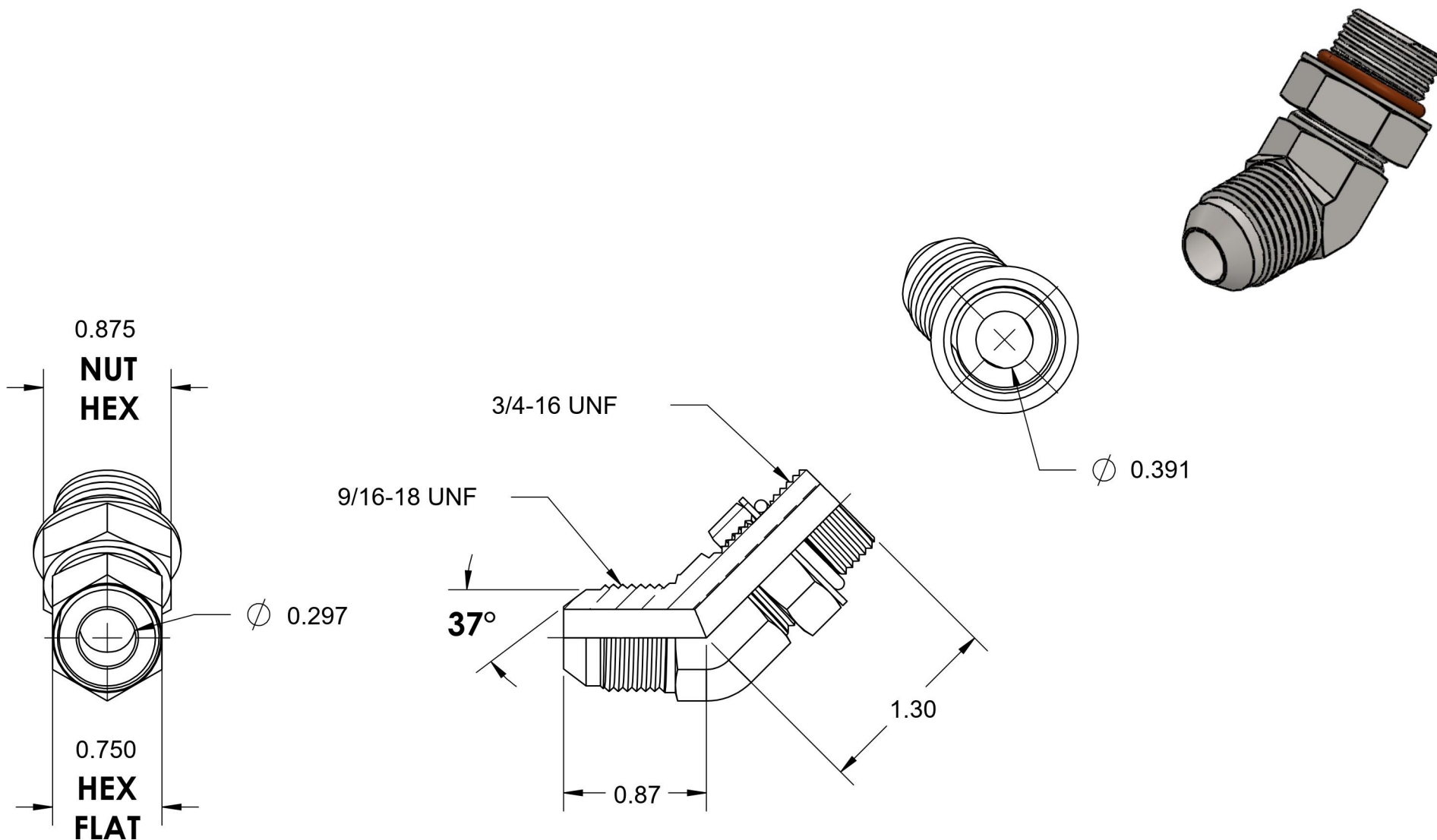

6701 Cochran Road  
Solon, Ohio 44139  
Phone: (440) 248-1880  
Toll Free: 1-888-331-1523

**Temperature Rating**

-15°F to 400°F

**Pressure Rating**

6000 psi

**Material**

C1045 Steel

**Finish**

Trivalent Zinc

**Industry Standards**

SAE J514, SAE J1926-3  
SAE J515, ASTM B633

**Series**

6802-NWO-FG-VITON

**Series Description**

SAE J514 37° Flare  
45° Adjustable Port Elbow