

D2404-L10-02-SS

Stainless Steel, DIN 2353 Male Connector, Light 10mm Tube OD x 1/8" NPT

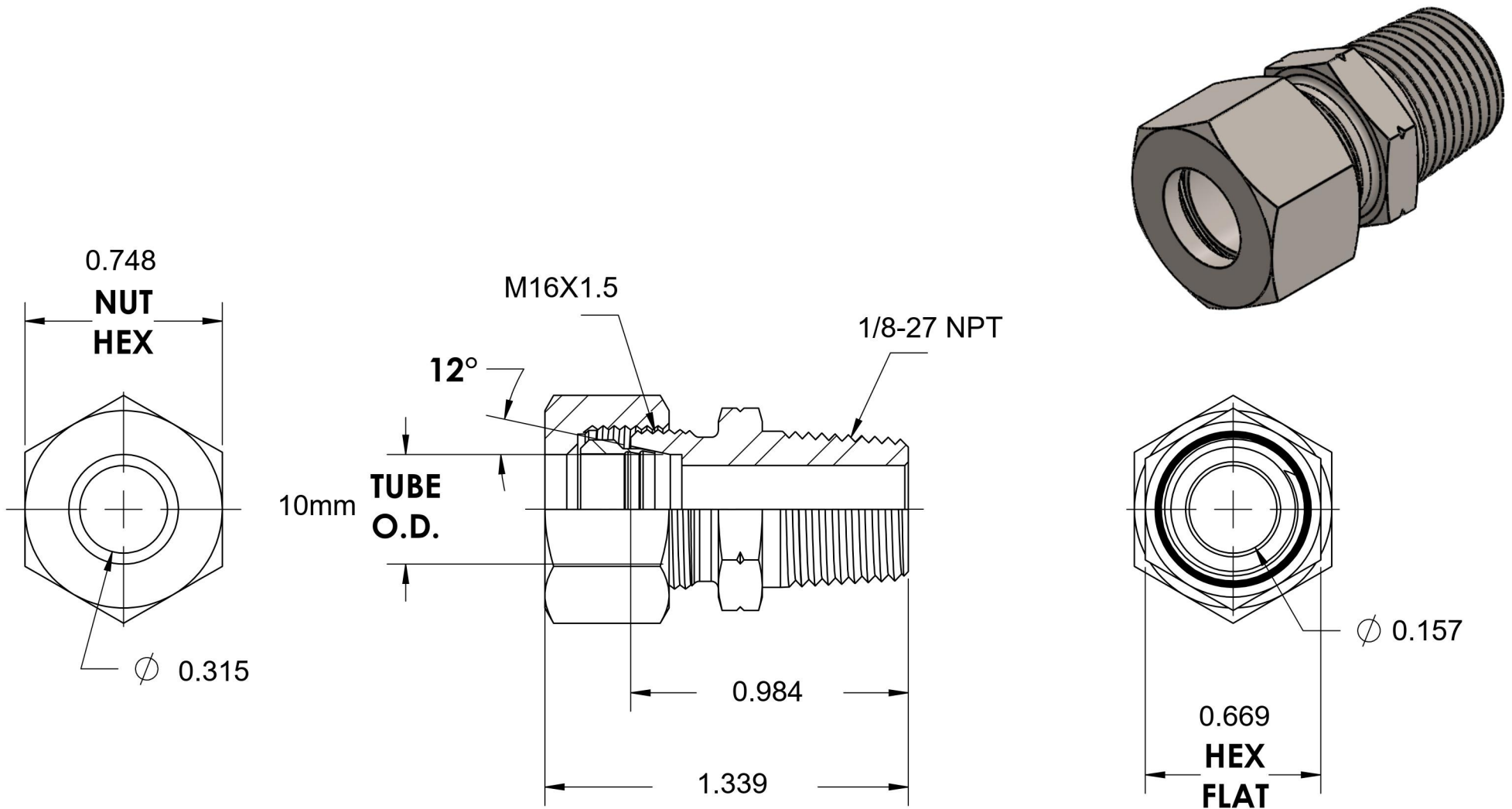

6701 Cochran Road
Solon, Ohio 44139
Phone: (440) 248-1880
Toll Free: 1-888-331-1523

Temperature Rating	Material	Industry Standards	Series
-425°F to 1200°F	316Ti Stainless	DIN 2353, ISO 8434-1 ANSI/ASME B1.20.1	D2404
Pressure Rating	Finish		Series Description
4569psi	Passivation		DIN 2353 Flareless Tube Male Connector