

2706-LN-08-08

Stainless Steel, SAE J514 Flared Tube Male Bulkhead, 1/2" Male NPTF 30° x 5/8" Male JIC

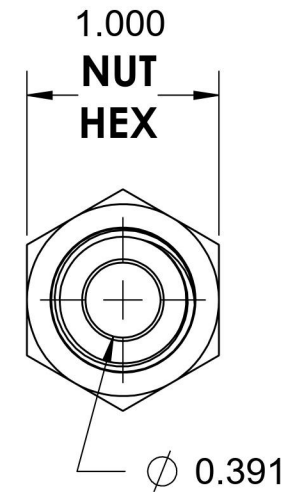
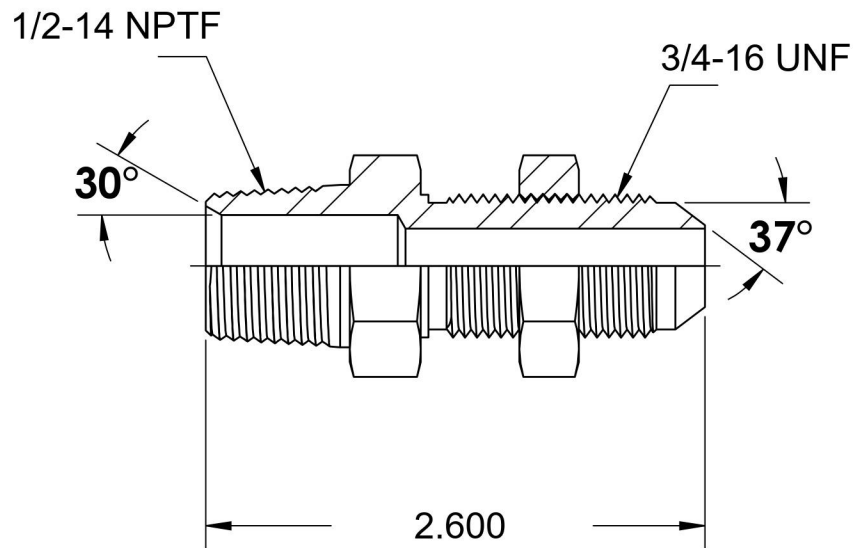
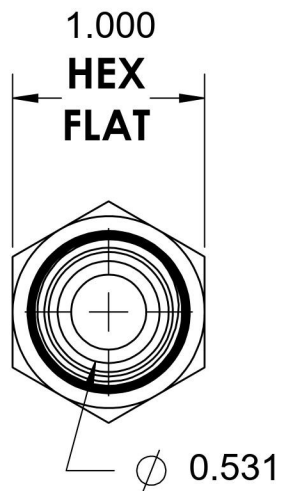
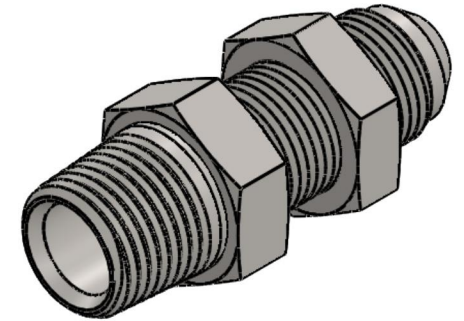

6701 Cochran Road
Solon, Ohio 44139
Phone: (440) 248-1880
Toll Free: 1-888-331-1523

Temperature Rating

-65°F to 500°F

Pressure Rating

6000 psi

Material

C1045/12L14 Steel

Finish

Trivalent Zinc

Industry Standards

SAE J514 , SAE J476
ASTM B633

Series

2706-LN

Series Description

SAE J514 Flared Tube
Male Bulkhead