

# 5503-08-08-B

Brass, SAE J514 Pipe 45° Street Elbow, 1/2" Male NPTF 30° x 1/2" Female NPTF

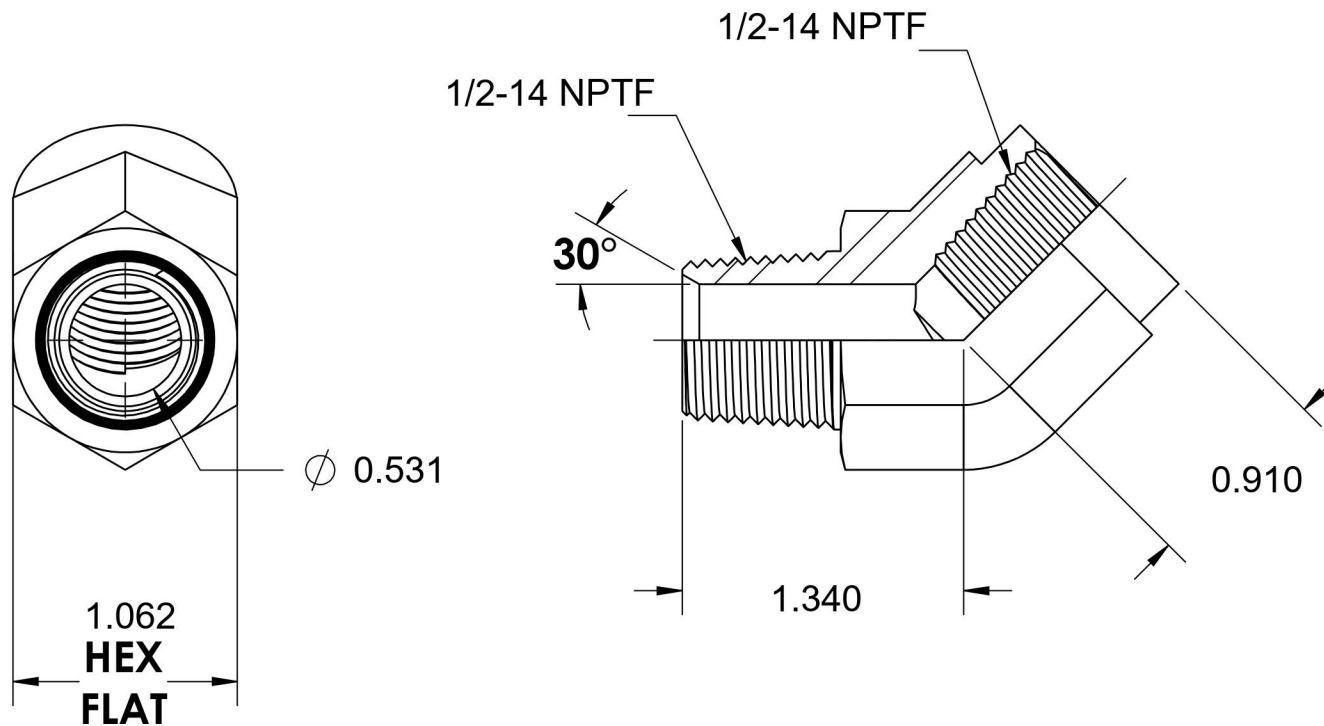
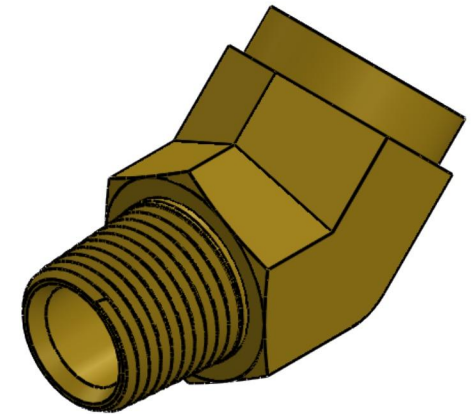

6701 Cochran Road  
Solon, Ohio 44139  
Phone: (440) 248-1880  
Toll Free: 1-888-331-1523

<b>Temperature Rating</b> -325°F to 400°F	<b>Material</b> CA37700 Brass	<b>Industry Standards</b> SAE J514, SAE J476	<b>Series</b> 5503-B
<b>Pressure Rating</b> 1900 psi	<b>Finish</b> Natural Finish		<b>Series Description</b> SAE J514 Pipe 45° Street Elbow