

6801-12-14-NWO-FG

Steel, SAE J514 37° Flare 90° Adjustable Port Elbow, 3/4" Male JIC x 1-3/16-12 Male Adjustable ORB

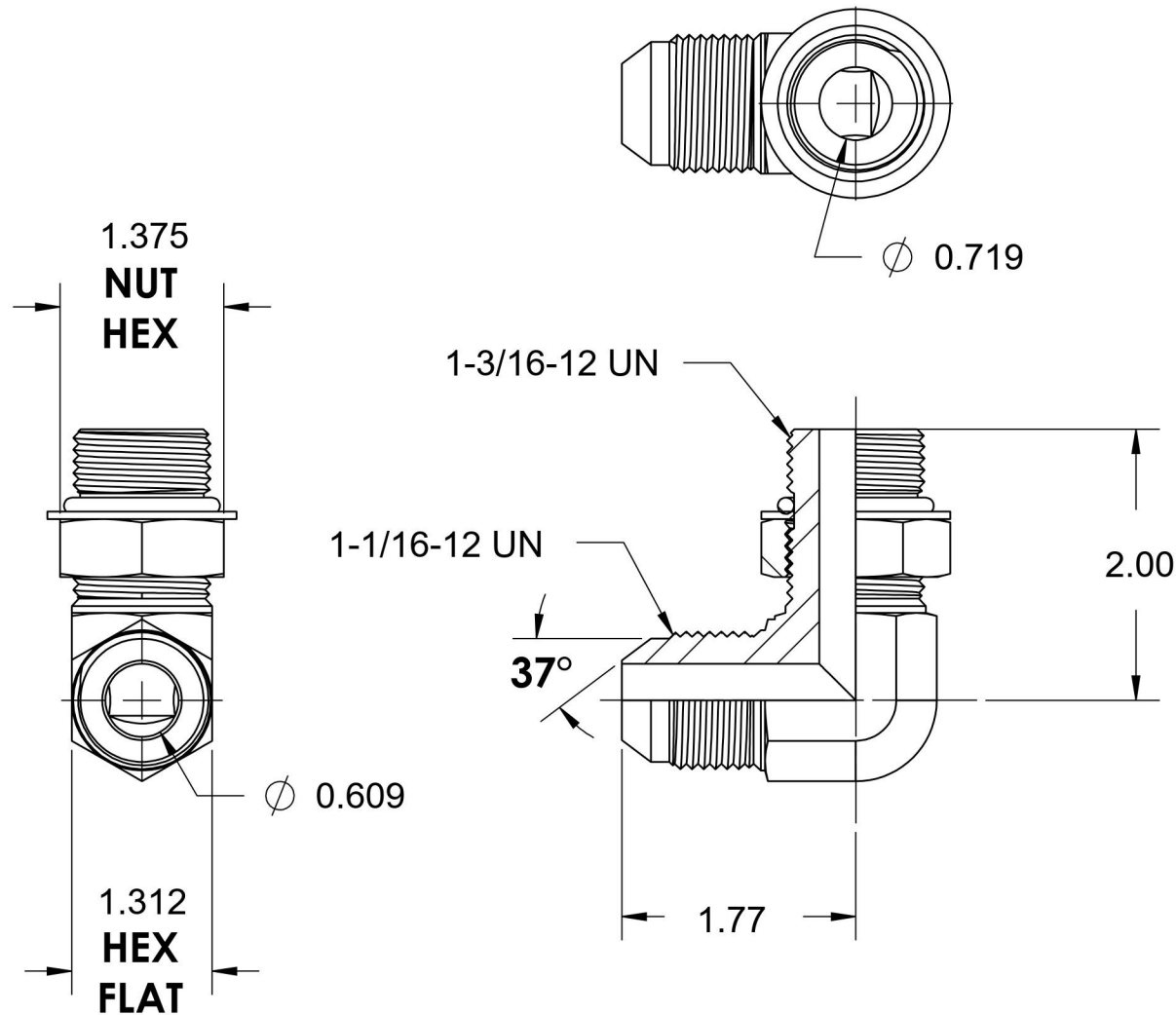

6701 Cochran Road
Solon, Ohio 44139
Phone: (440) 248-1880
Toll Free: 1-888-331-1523

Temperature Rating	Material	Industry Standards	Series
-40°F / 250°F	C1045 Steel	SAE J514, SAE J1926-3	6801-NWO-FG
Pressure Rating	Finish	ASTM B633	Series Description
5000 psi	Trivalent Zinc		SAE J514 37° Flare 90° Adjustable Port Elbow