

C2501-16-16-SS

Stainless Steel, SAE J514 Flareless Tube 90° Male Elbow, 1" Flareless Bite Type x 1" Male NPTF 30°

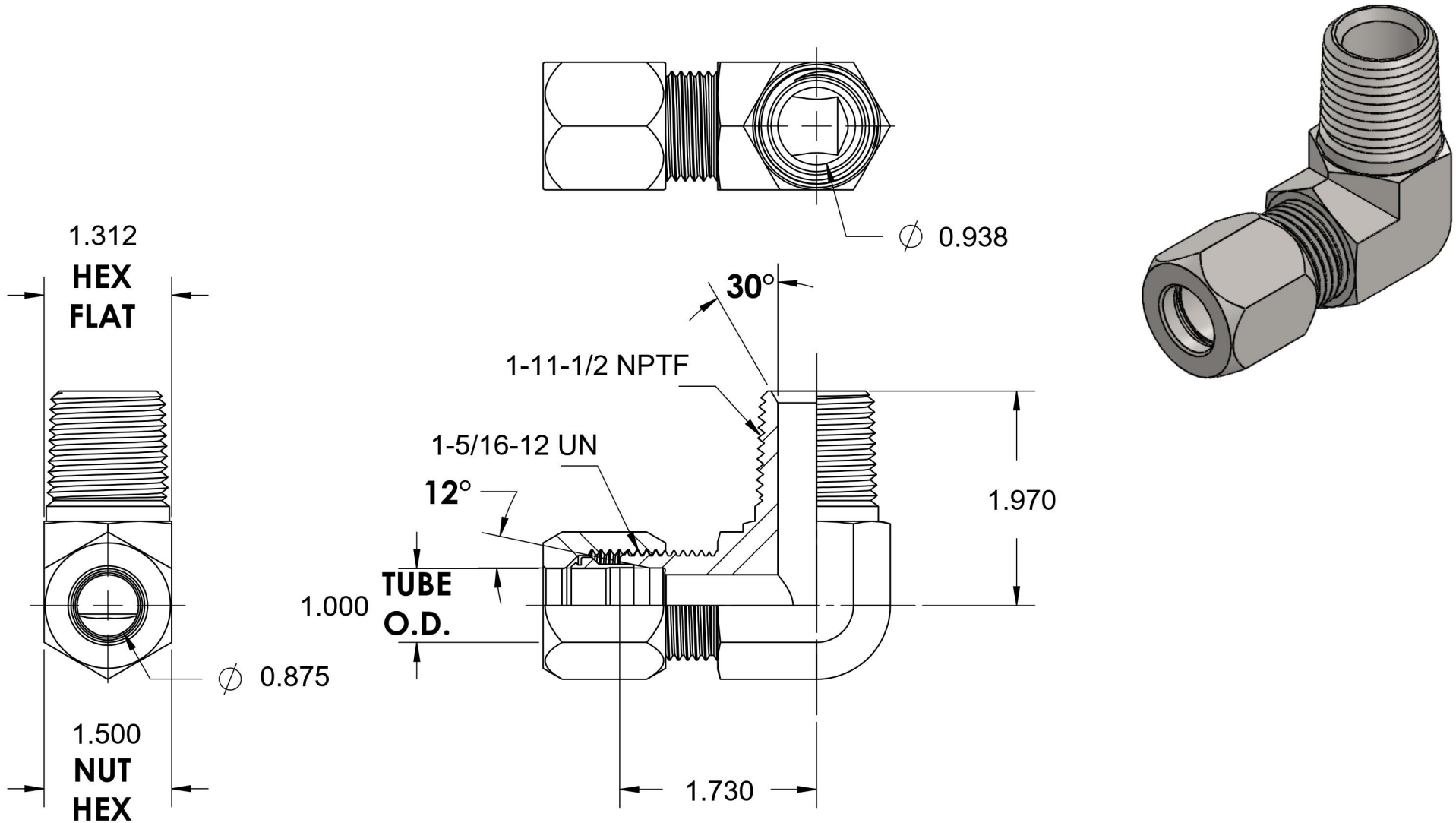

6701 Cochran Road
Solon, Ohio 44139
Phone: (440) 248-1880
Toll Free: 1-888-331-1523

Temperature Rating	Material	Industry Standards	Series
-425°F to 1200°F	316/316L Stainless Steel	SAE J514, SAE J476	C2501-SS
Pressure Rating	Finish		Series Description
3000 psi	Passivated		SAE J514 Flareless Tube 90° Male Elbow