

6902-16-12-NWO-FG

Steel, SAE J514 NPSM Swivel 45° Adjustable Port Elbow, 1-5/16-12 Male Adjustable ORB x 3/4" Female NPSM Swivel

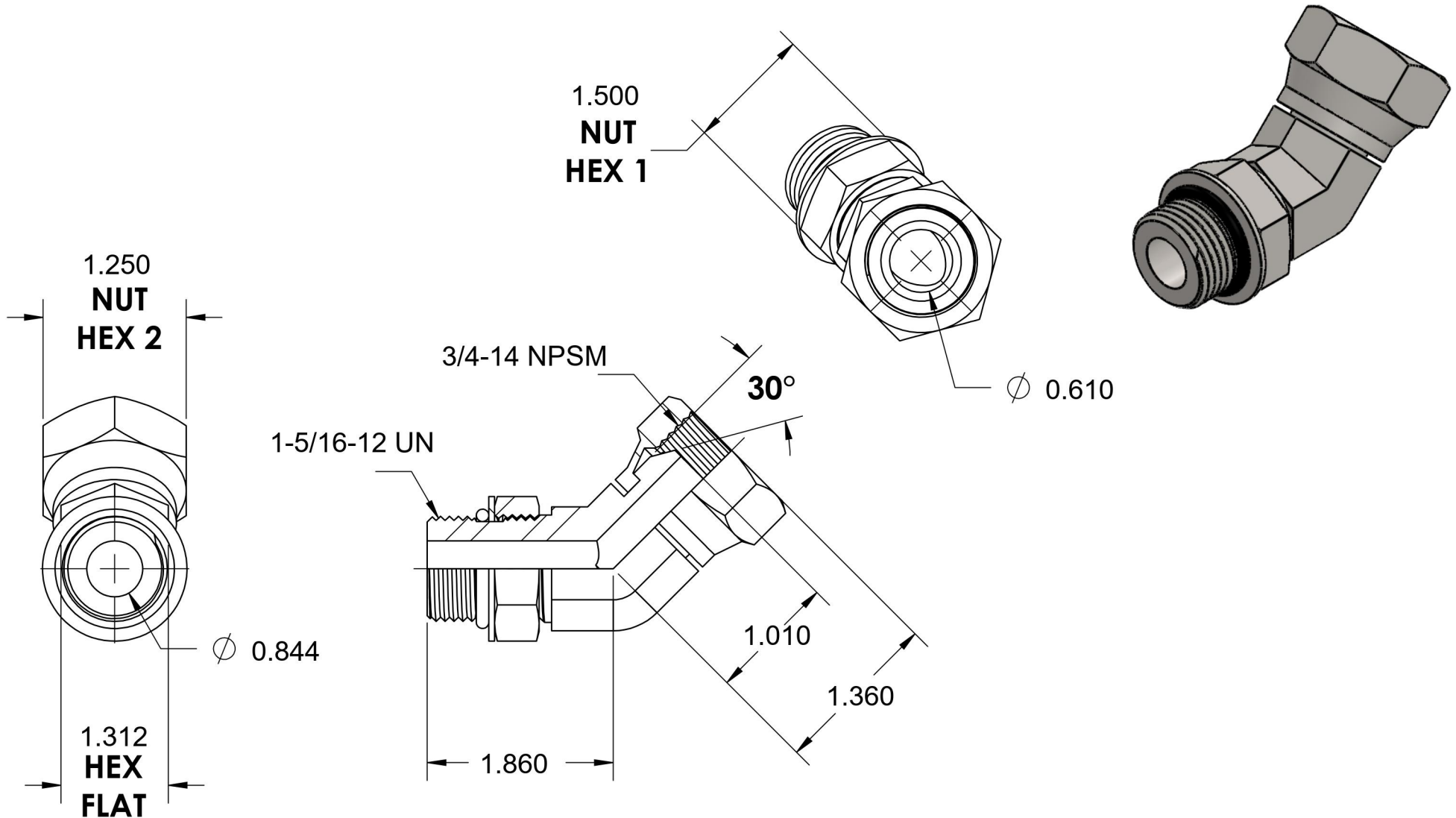

6701 Cochran Road
Solon, Ohio 44139
Phone: (440) 248-1880
Toll Free: 1-888-331-1523

Temperature Rating	Material	Industry Standards	Series
-40°F to 250°F	C1045 Steel	SAE J514, SAE J1926-3 SAE J515, ASTM B633	6902-NWO-FG
Pressure Rating	Finish		Series Description
2500psi	Trivalent Zinc		SAE J514 NPSM Swivel 45° Adjustable Port Elbow