

1724-08

08 O-Ring Face Flange Plug Code 61

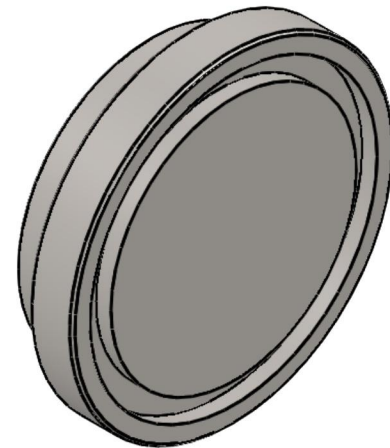
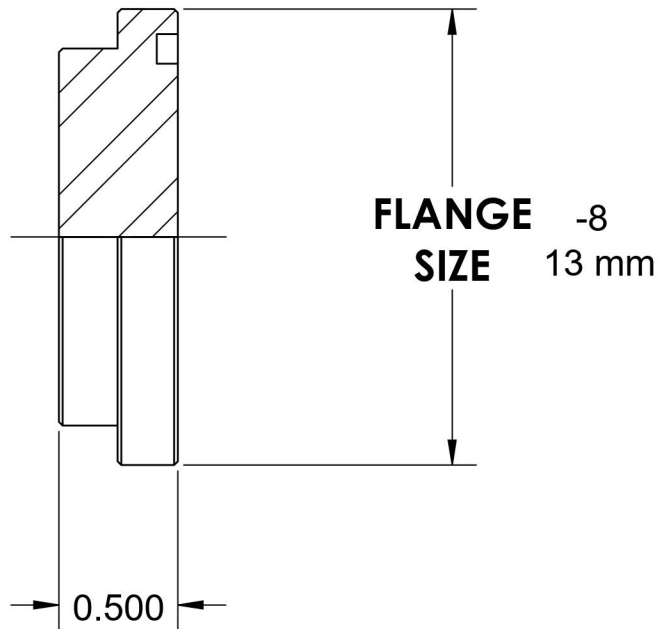
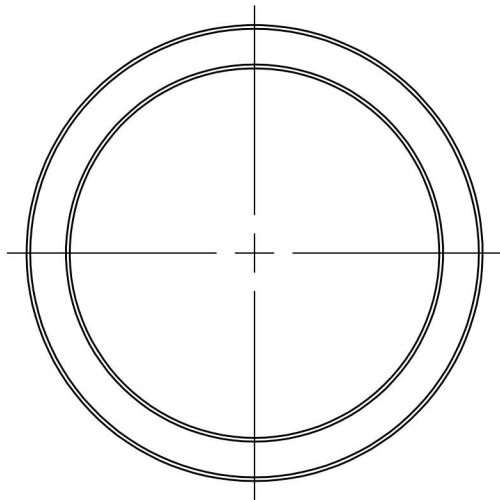

6701 Cochran Road
Solon, Ohio 44139
Phone: (440) 248-1880
Toll Free: 1-888-331-1523

Temperature Rating -65°F to 500°F	Material C1045/12L14 Steel	Industry Standards SAE J518 Code 61 ASTM B633	Series 1724
Pressure Rating 5000 psi	Finish Trivalent Zinc		Series Description SAE J518 Code 61 Split Flange Plug