

6802-08-06-NWO-FG

Steel, SAE J514 37° Flare 45° Adjustable Port Elbow, 1/2" Male JIC x 9/16-18 Male Adjustable ORB

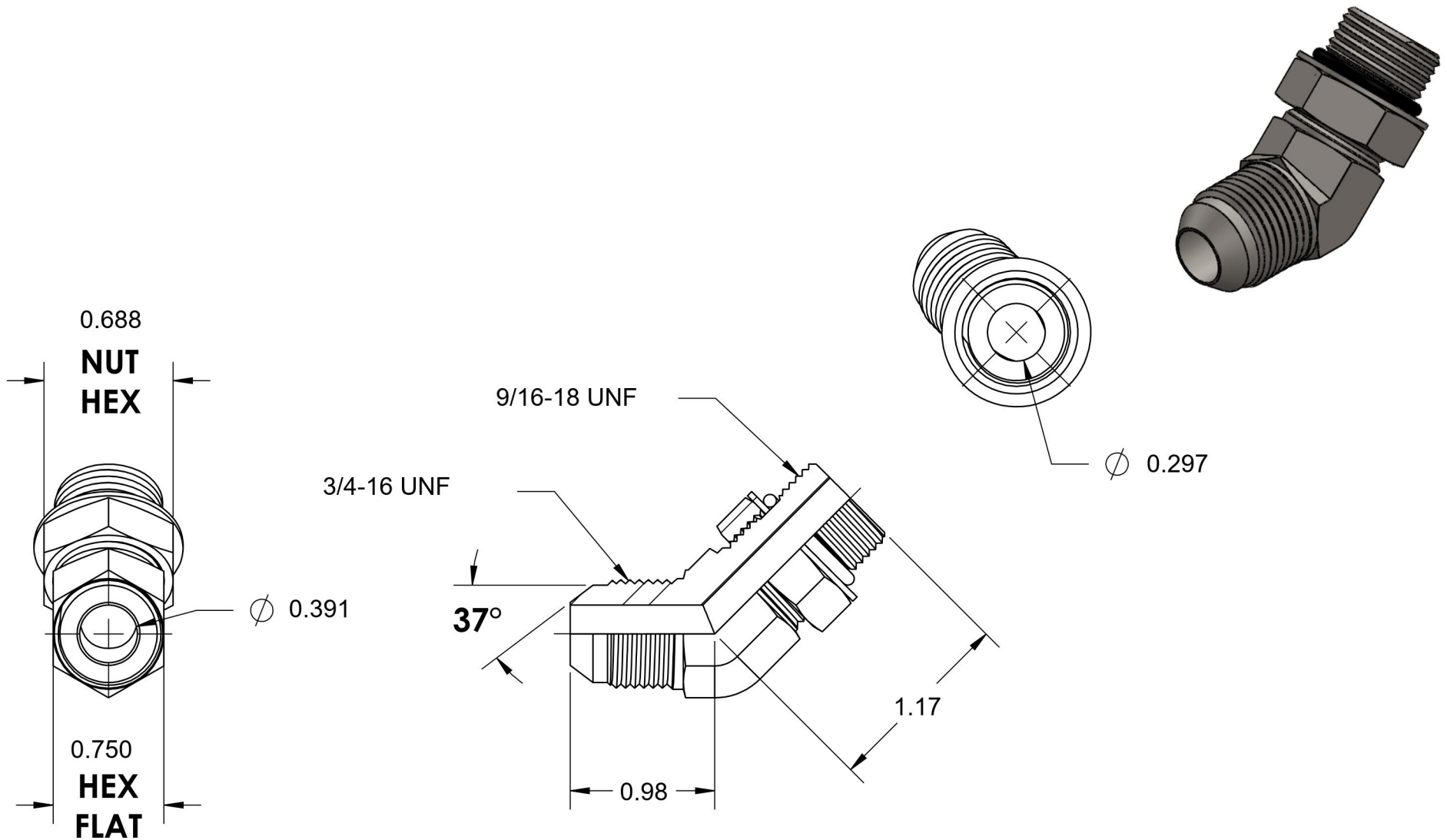

6701 Cochran Road
Solon, Ohio 44139
Phone: (440) 248-1880
Toll Free: 1-888-331-1523

Temperature Rating	Material	Industry Standards	Series
-40°F to 250°F	C1045 Steel	SAE J514, SAE J1926-3	6802-NWO-FG
Pressure Rating	Finish	SAE J515, ASTM B633	Series Description
6000 psi	Trivalent Zinc		SAE J514 37° Flare 45° Adjustable Port Elbow