

7022-24-20

Steel, SAE J514 37° Flare Swivel Male BSPP Port/Line Connector, 1-1/2" Female JIC Swivel x 1-1/4-11 Male BSPP 60° Line/Port

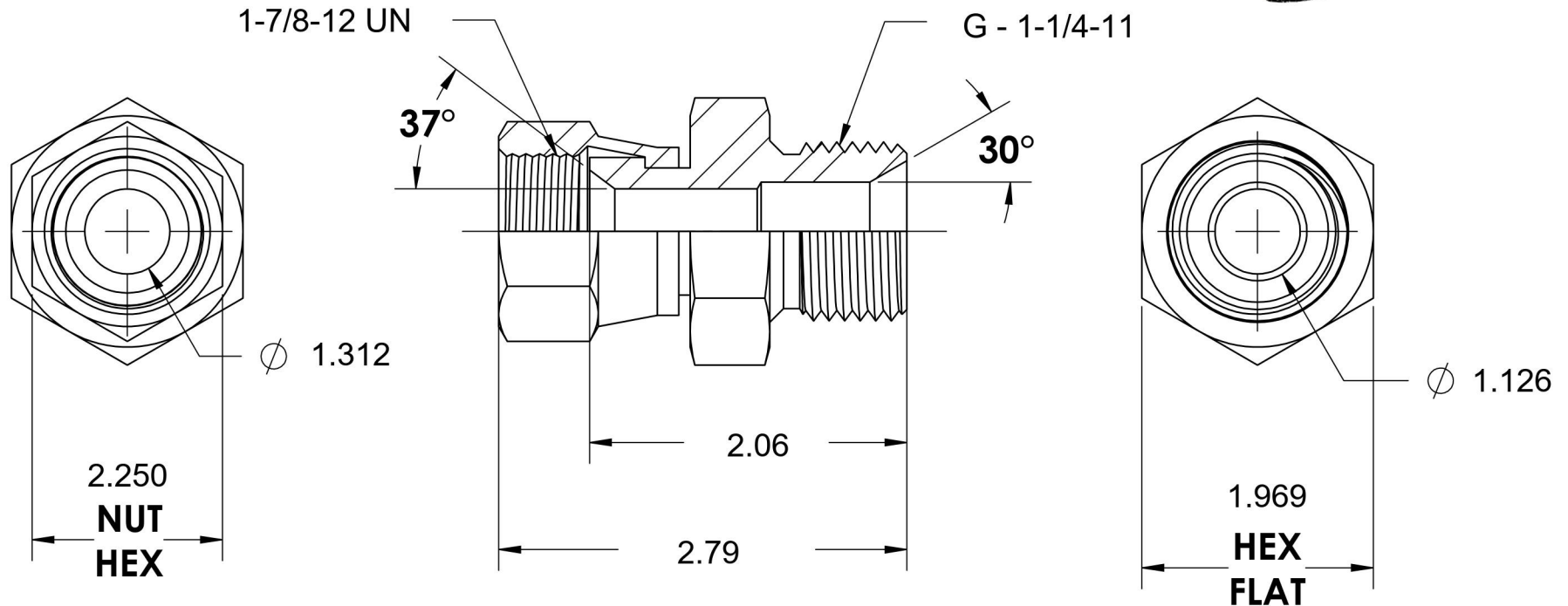
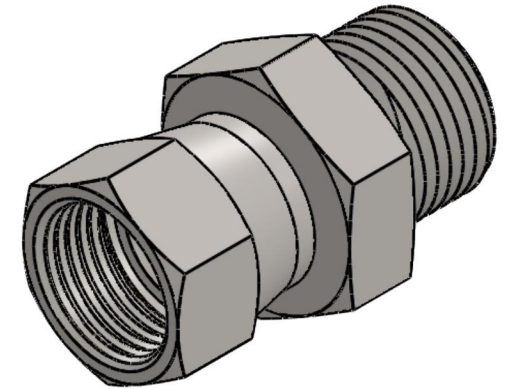

6701 Cochran Road
Solon, Ohio 44139
Phone: (440) 248-1880
Toll Free: 1-888-331-1523

Temperature Rating

-65°F to 500°F

Pressure Rating

1500 psi

Material

C1045 / 12L14 Steel

Finish

Trivalent Zinc

Industry Standards

SAE J514, ISO 1179

ISO 8434-6, ASTM B633

Series

7022

Series Description

SAE J514 37° Flare Swivel Male
BSPP Port/Line Connector