

6502-02-02-FG

Steel, SAE J514 37° Flare 45° Swivel Elbow, 1/8" Male JIC x 1/8" Female JIC Swivel

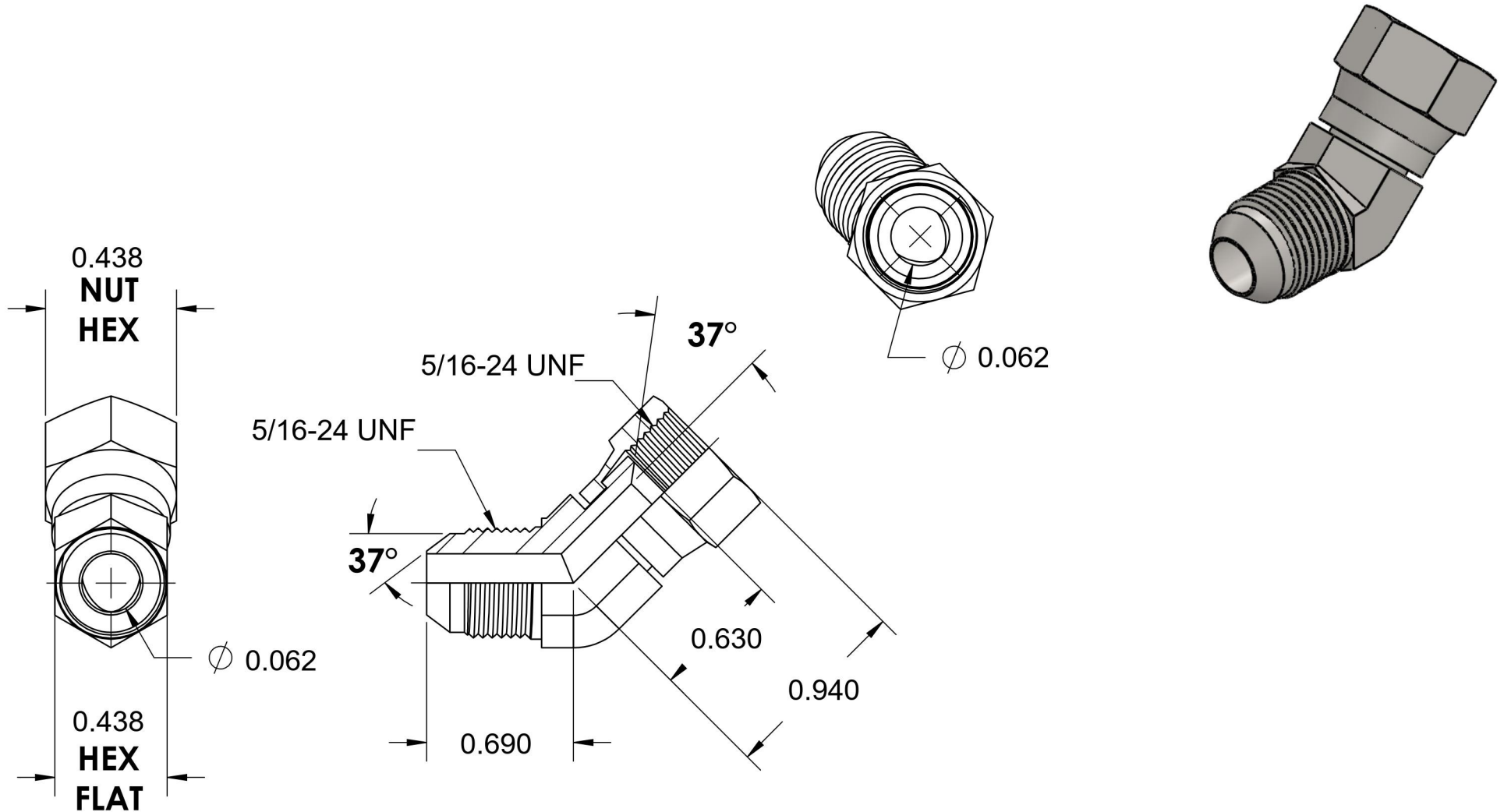

6701 Cochran Road
Solon, Ohio 44139
Phone: (440) 248-1880
Toll Free: 1-888-331-1523

Temperature Rating	-65°F to 500°F	Material	C1045 Steel	Industry Standards	SAE J514, ASTM B633	Series	6502-FG
Pressure Rating	7500 psi	Finish	Trivalent Zinc			Series Description	SAE J514 37° Flare 45° Swivel Elbow