

C0319-14-SS

Stainless Steel, SAE J514 Flareless Tube Ferrule, 7/8" Flareless Bite Type Sleeve Type A

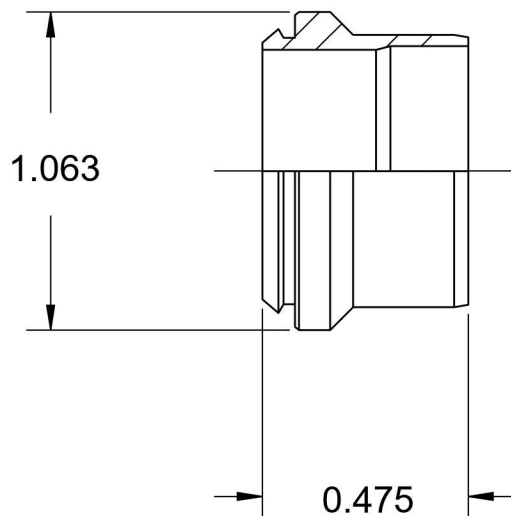
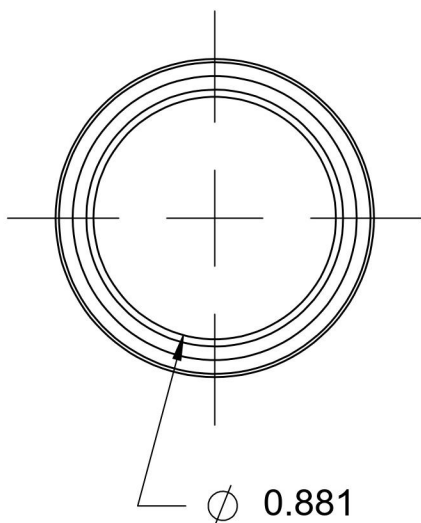

6701 Cochran Road
Solon, Ohio 44139
Phone: (440) 248-1880
Toll Free: 1-888-331-1523

Temperature Rating	Material	Industry Standards SAE J514	Series C0319
-425°F to 1200°F	17-4 PH Stainless Steel		
Pressure Rating	Finish	Series Description	
Not Available	Passivation	SAE J514 Flareless Tube Ferrule	