

1704-24-24

Steel, SAE J514 37° Flare 90° Code 61 Flange Swept Elbow, 1-1/2" Male JIC x 1-1/2" Split Flange Head

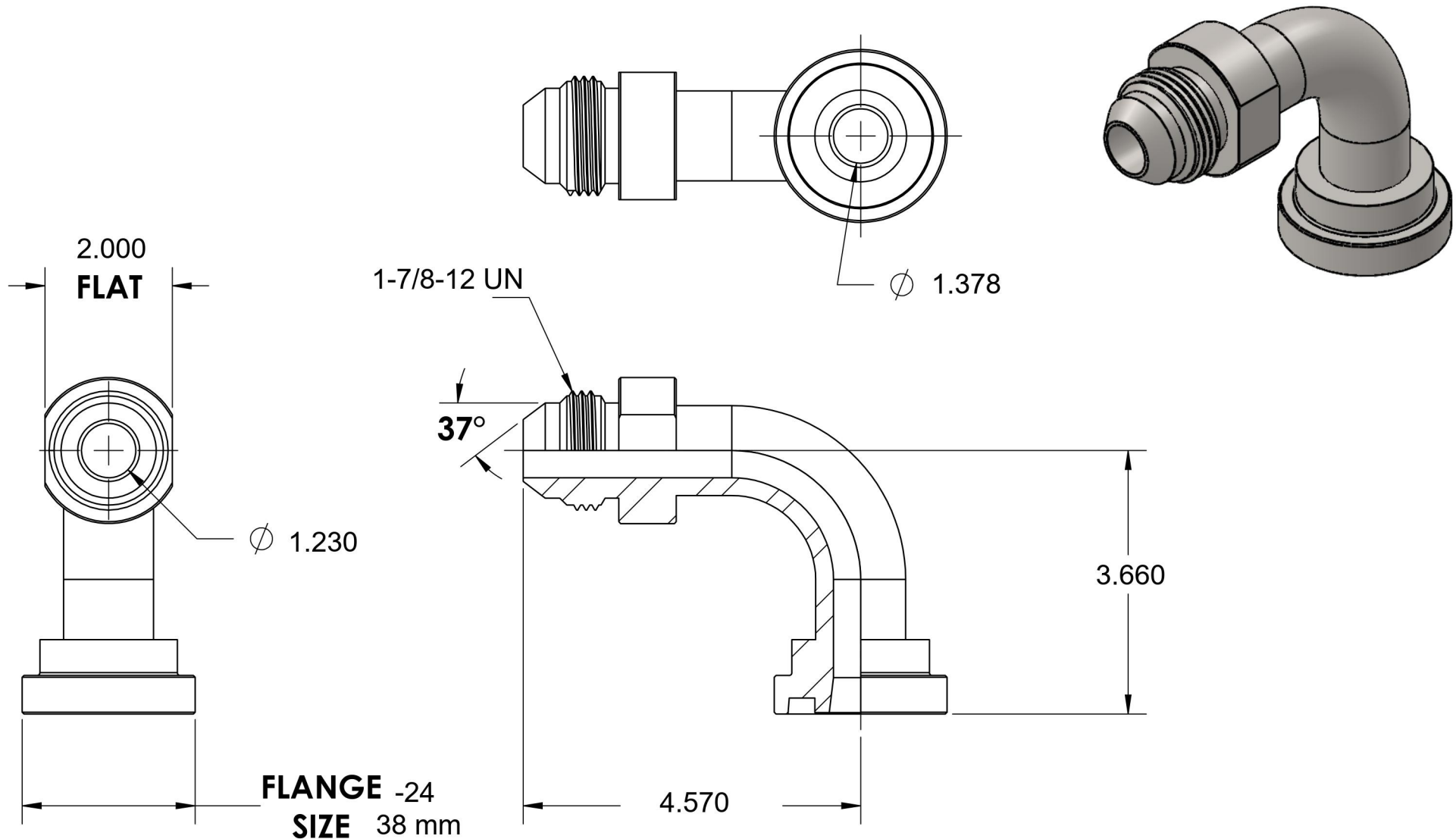

6701 Cochran Road
Solon, Ohio 44139
Phone: (440) 248-1880
Toll Free: 1-888-331-1523

Temperature Rating	Material	Industry Standards	Series
-65°F to 500°F	S20C Steel	SAE J518 Code 61, SAE J514 ASTM B633	1704
Pressure Rating	Finish		Series Description
3000 psi	Trivalent Zinc		SAE J514 37° Flare 90° Code 61 Flange Swept Elbow