

6806-10-08-NWO-SS

Stainless Steel, SAE J1926 Adjustable O-Ring Boss 90° Male Elbow, 7/8-14 Male Adjustable ORB x 1/2" Male NPTF 30°

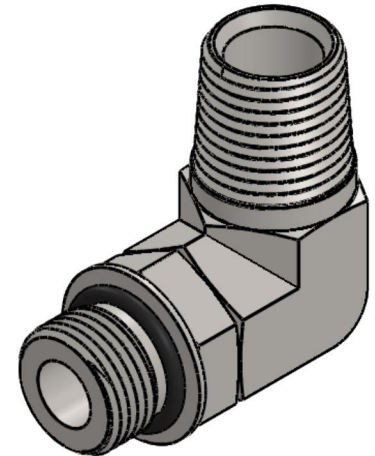
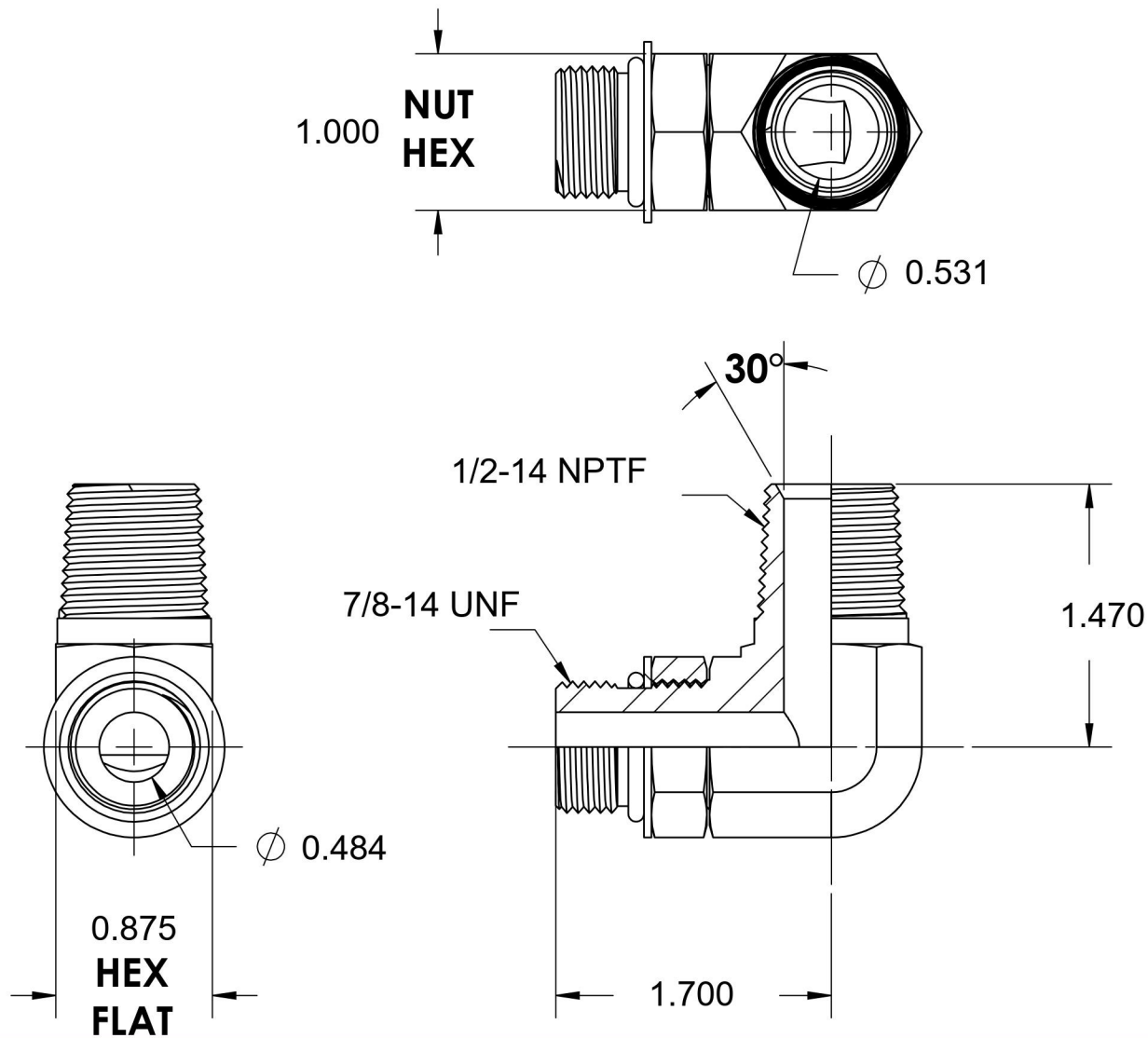

6701 Cochran Road
Solon, Ohio 44139
Phone: (440) 248-1880
Toll Free: 1-888-331-1523

Temperature Rating	Material	Industry Standards	Series
-40°F to 250°F	316/316L Stainless Steel	SAE J1926-3, SAE J476 SAE J515	6806-NWO-SS
Pressure Rating	Finish		Series Description
3000 psi	Passivated		SAE J1926 Adjustable O-Ring Boss 90° Male Elbow