

2404-20-32-SS

Stainless Steel, SAE J514 37° Flare Male Connector, 1-1/4" Male JIC x 2" Male NPTF 30°

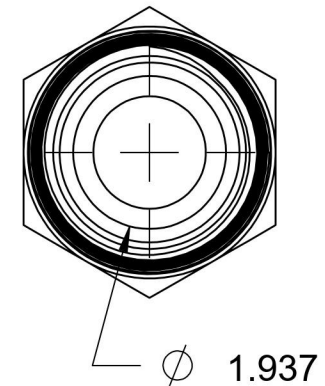
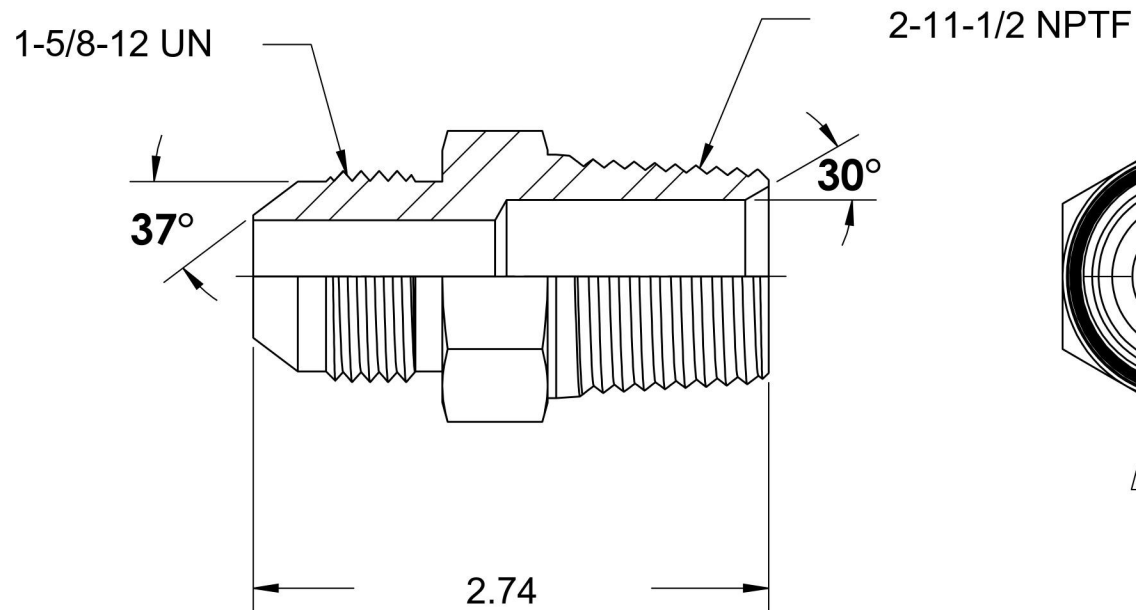
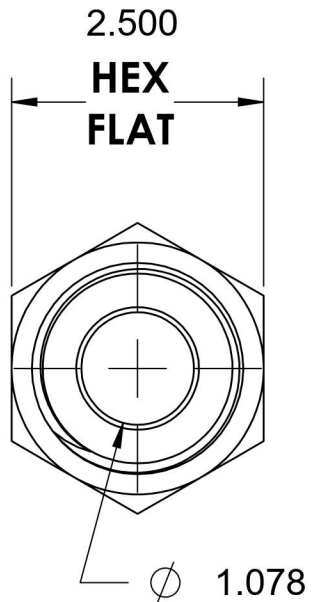

6701 Cochran Road
Solon, Ohio 44139
Phone: (440) 248-1880
Toll Free: 1-888-331-1523

Temperature Rating	Material	Industry Standards SAE J514 , SAE J476	Series
-425°F to 1200°F	316/316L Stainless Steel		2404-SS
Pressure Rating	Finish		Series Description
2000 psi	Passivated		SAE J514 37° Flare Male Connector