

6502-12-12-FG

Steel, SAE J514 37° Flare 45° Swivel Elbow, 3/4" Male JIC x 3/4" Female JIC Swivel

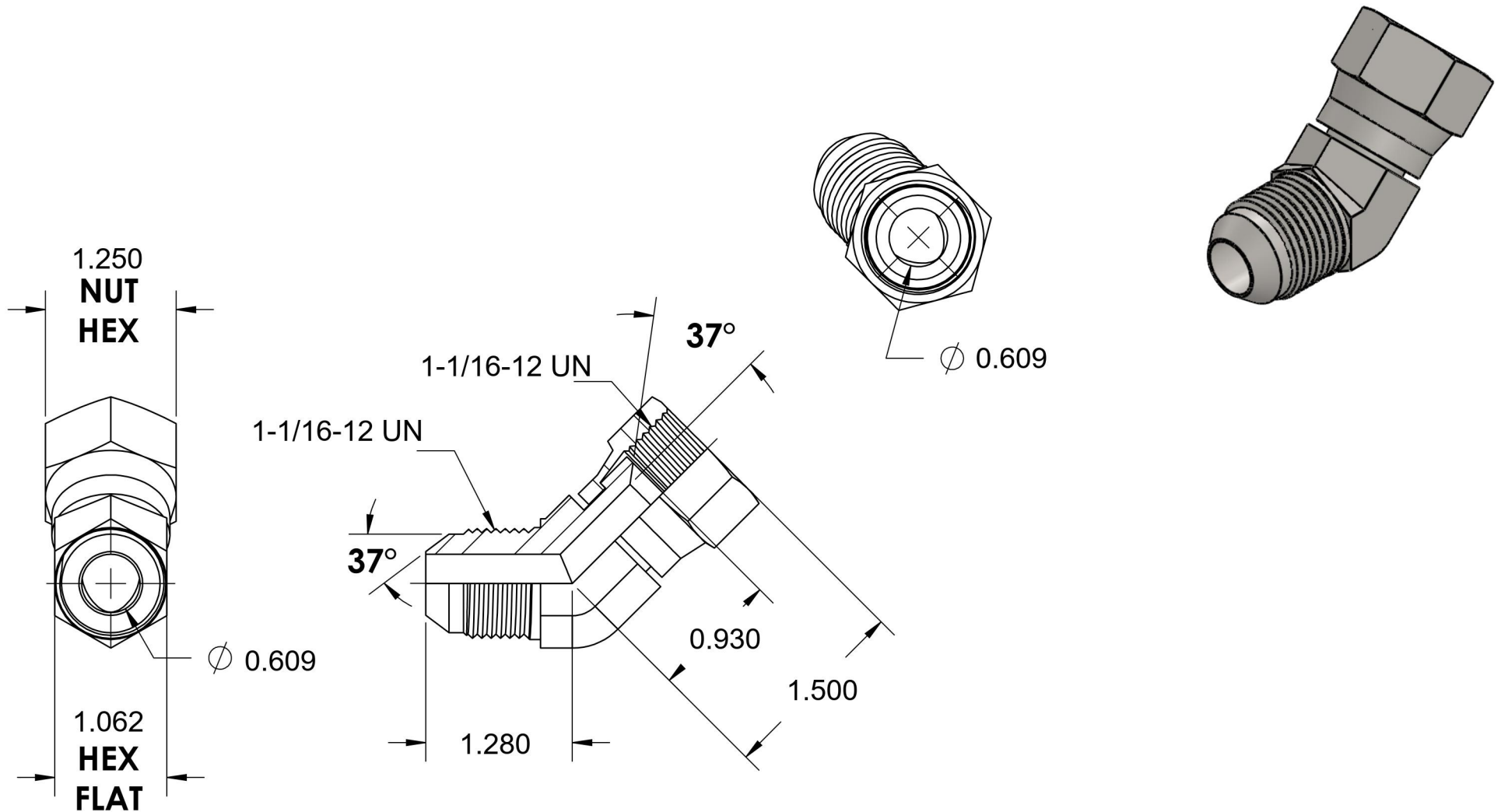

6701 Cochran Road
Solon, Ohio 44139
Phone: (440) 248-1880
Toll Free: 1-888-331-1523

Temperature Rating	Material	Industry Standards	Series
-65°F to 500°F	C1045 Steel	SAE J514, ASTM B633	6502-FG
Pressure Rating	Finish	Series Description	
5000 psi	Trivalent Zinc	SAE J514 37° Flare 45° Swivel Elbow	