

# 7004-08-10

## Steel, SAE J514 37° Flare BSPP Swivel Line Adapter, 1/2" Male JIC x 5/8-14 Female BSPP Swivel

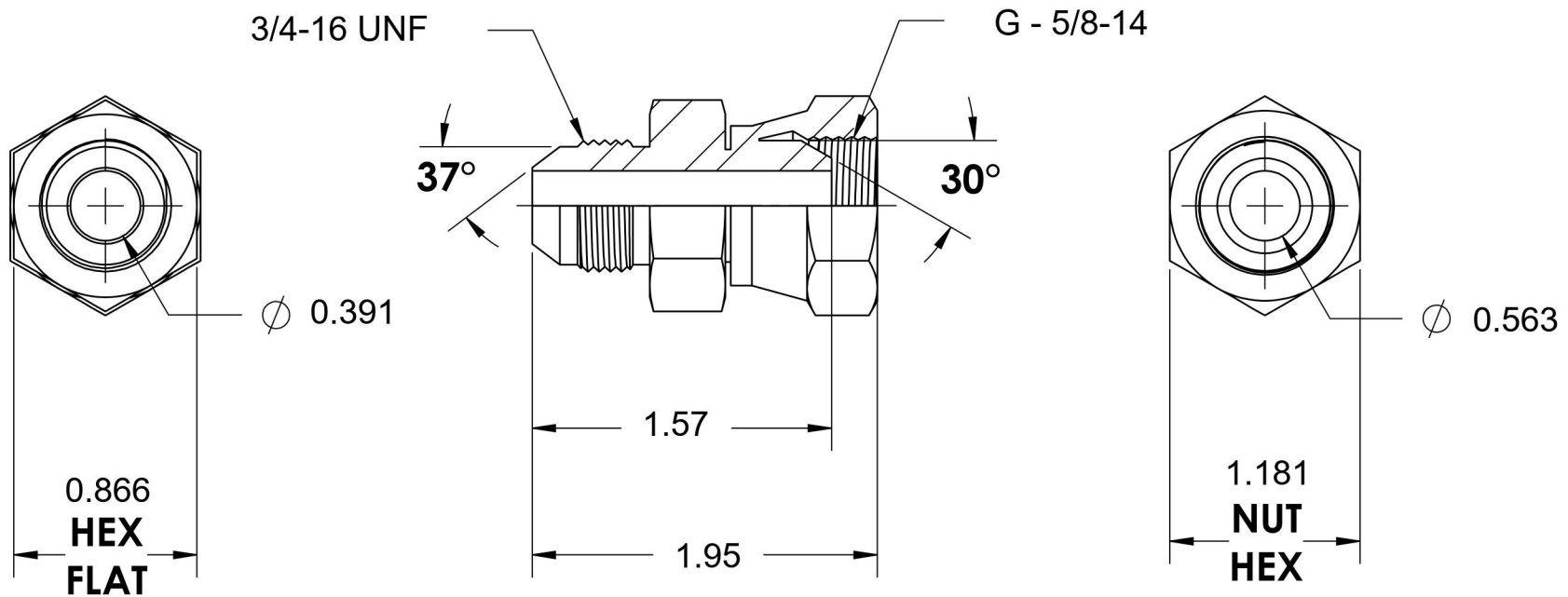
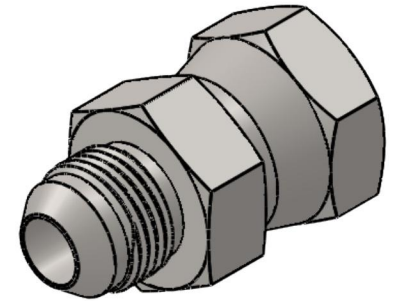

6701 Cochran Road  
Solon, Ohio 44139  
Phone: (440) 248-1880  
Toll Free: 1-888-331-1523

**Temperature Rating**

-65°F to 500°F

**Pressure Rating**

4000 psi

**Material**

C1045 / 12L14 Steel

**Finish**

Trivalent Zinc

**Industry Standards**

SAE J514, ISO 8434-6

ASTM B633

**Series**

7004

**Series Description**

SAE J514 37° Flare BSPP  
Swivel Line Adapter