

C2501-06-02-SS

Stainless Steel, SAE J514 Flareless Tube 90° Male Elbow, 3/8" Flareless Bite Type x 1/8" Male NPTF 30°

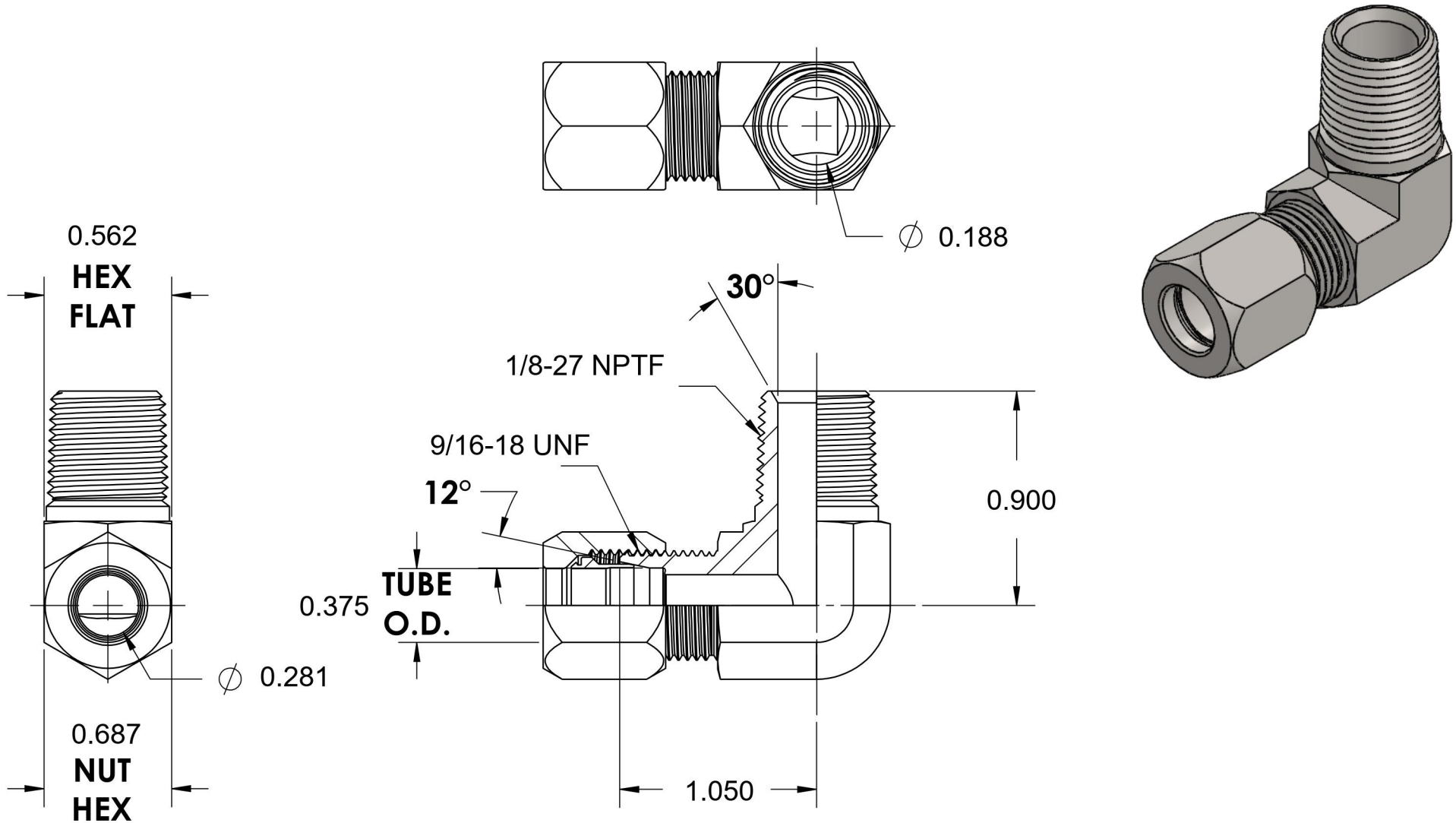

6701 Cochran Road
Solon, Ohio 44139
Phone: (440) 248-1880
Toll Free: 1-888-331-1523

| | | | |
|---------------------------|--------------------------|---------------------------|---|
| Temperature Rating | Material | Industry Standards | Series |
| -425°F to 1200°F | 316/316L Stainless Steel | SAE J514, SAE J476 | C2501-SS |
| Pressure Rating | Finish | | Series Description |
| 5000 psi | Passivated | | SAE J514 Flareless Tube 90° Male Elbow |