

# 2501-10-04-FG

Steel, SAE J514 37° Flare 90° Male Elbow, 5/8" Male JIC x 1/4" Male NPTF 30°

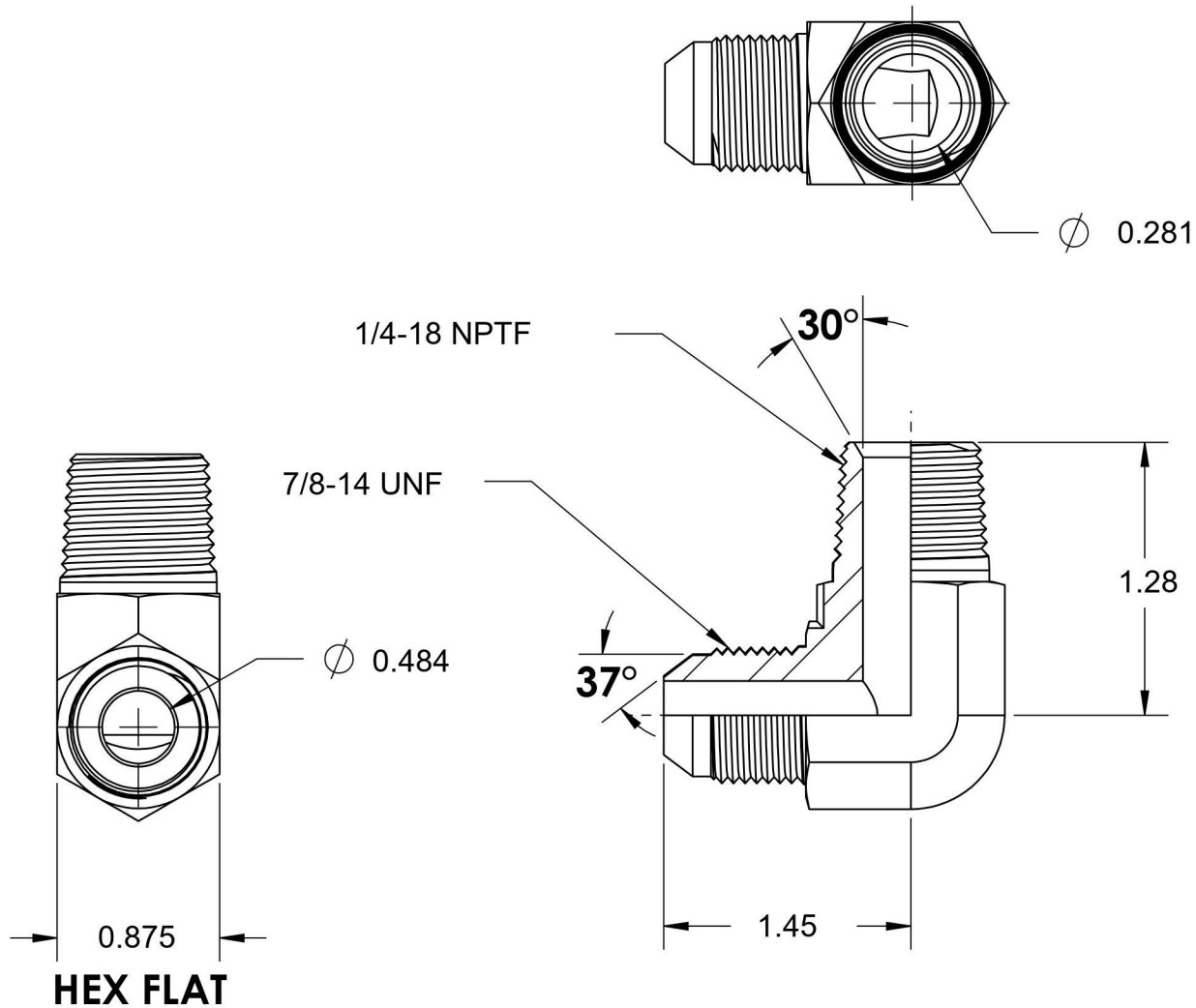

6701 Cochran Road  
Solon, Ohio 44139  
Phone: (440) 248-1880  
Toll Free: 1-888-331-1523

#### Temperature Rating

-65°F to 500°F

#### Pressure Rating

5000 psi

#### Material

C1045 Steel

#### Finish

Trivalent Zinc

#### Industry Standards

SAE J514, SAE J476

ASTM B633

#### Series

2501-FG

#### Series Description

SAE J514 37° Flare 90° Male Elbow