

6815-32-32-NWO-FG

Steel, SAE J1926 Adjustable O-Ring Boss 90° Female Port Elbow, 2-1/2-12 Male Adjustable ORB x 2-1/2-12 Female ORB

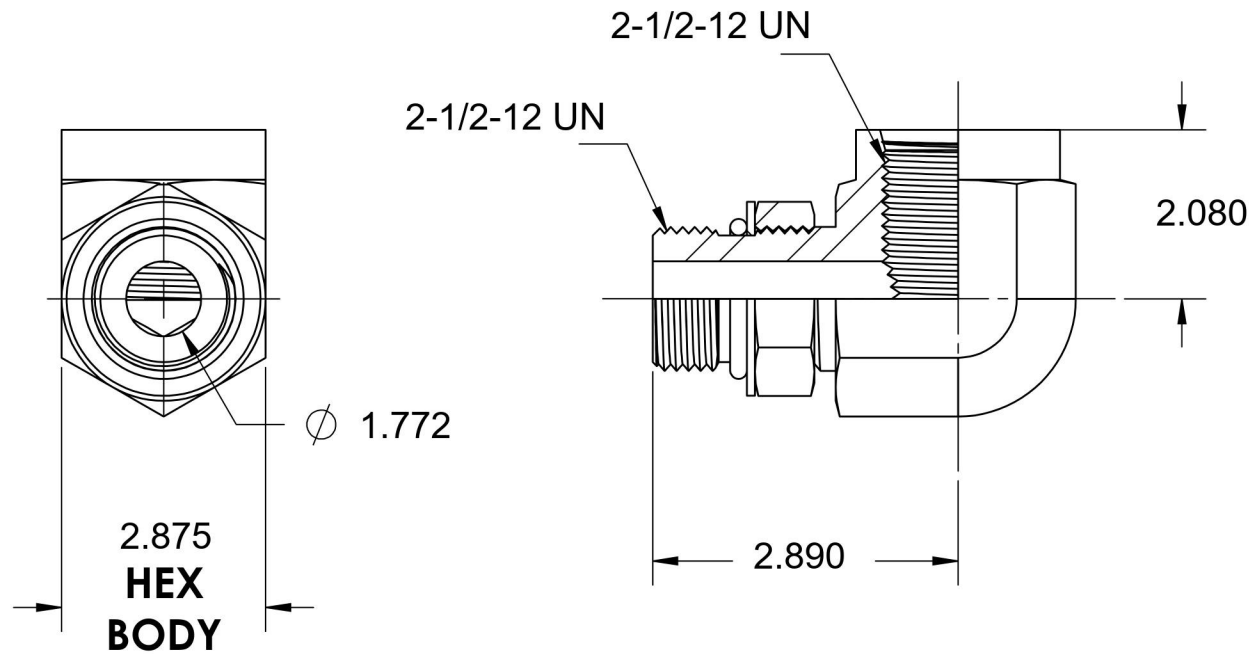
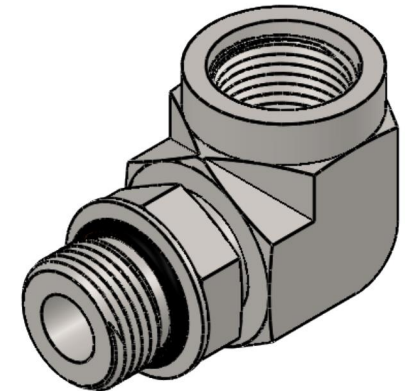
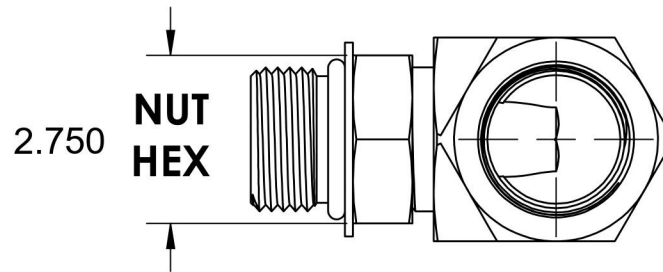

6701 Cochran Road
Solon, Ohio 44139
Phone: (440) 248-1880
Toll Free: 1-888-331-1523

Temperature Rating	Material	Industry Standards	Series
-40°F to 250°F	C1045 Steel	SAE J1926-1,-3, SAE J515 ASTM B633	6815-NWO-FG
Pressure Rating	Finish		Series Description
1500 psi	Trivalent Zinc		SAE J1926 Adjustable O-Ring Boss 90° Female Port Elbow