

# FS6403-10-10

Steel, SAE J1453/J514 Conversion Adapter, 5/8" Male ORFS x 5/8" Male JIC

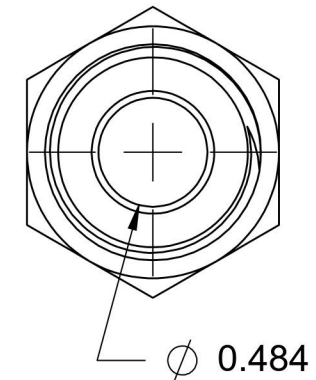
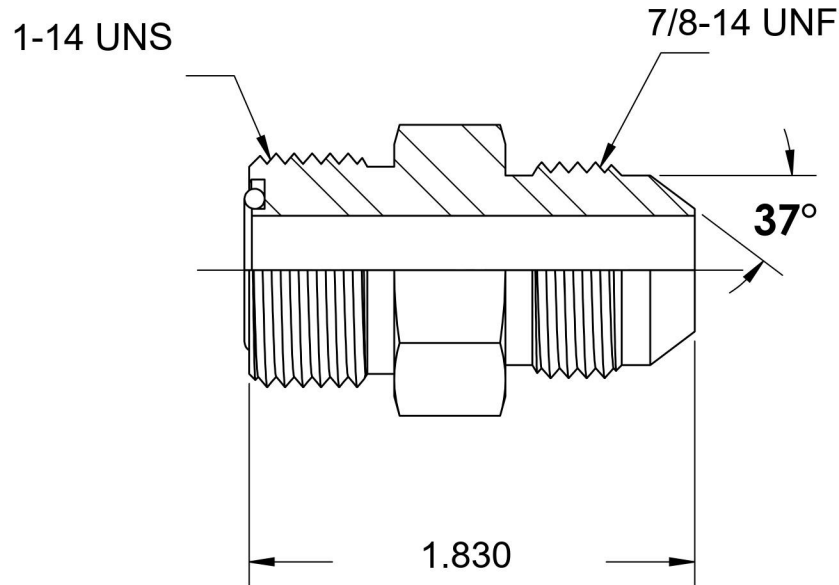
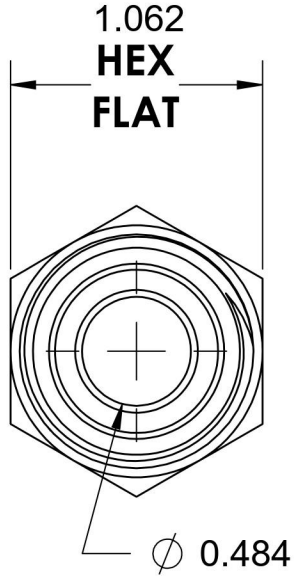
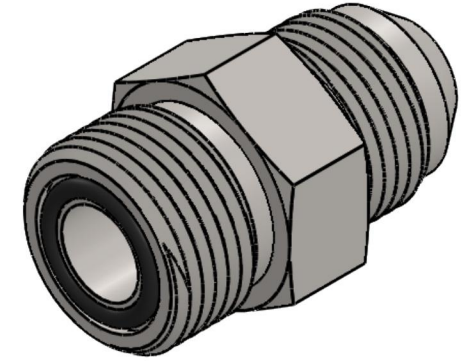

6701 Cochran Road  
Solon, Ohio 44139  
Phone: (440) 248-1880  
Toll Free: 1-888-331-1523

<b>Temperature Rating</b>	<b>Material</b>	<b>Industry Standards</b>	<b>Series</b>
-40°F to 250°F	C1045/12L14 Steel	SAE J1453, SAE J514 SAE J515, ASTM B633	FS6403
<b>Pressure Rating</b>	<b>Finish</b>		<b>Series Description</b>
5000 psi	Trivalent Zinc		SAE J1453 O-Ring Face Seal Male Flared Adapter