

D0319-35

Steel, DIN 2353 Double Bite Cutting Ring, 35mm Tube OD

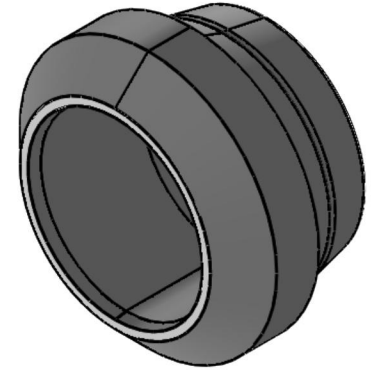
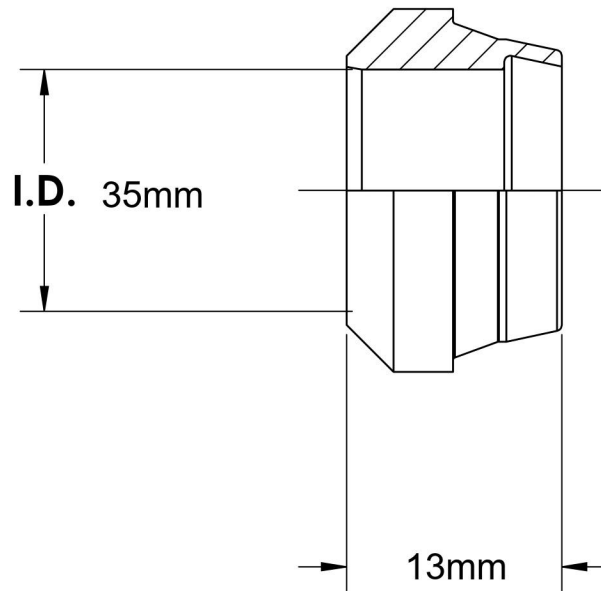
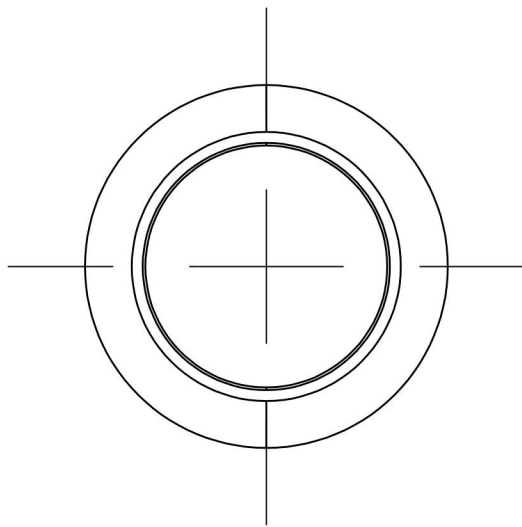

6701 Cochran Road
Solon, Ohio 44139
Phone: (440) 248-1880
Toll Free: 1-888-331-1523

Temperature Rating

-65°F to 500°F

Pressure Rating

3626psi

Material

Carbon Steel

Finish

Zinc Nickel

Industry Standards

DIN 2353, ISO 8434-1

Series

D0319

Series Description

DIN 2353 Flareless
Double Bite Tube Sleeve