

7002-08-08-B2351

Steel, SAE J514 37° Flare Male BSPP (JIS B2351) Port Connector, 1/2" Male JIC x 1/2-14 Male BSPP ORB

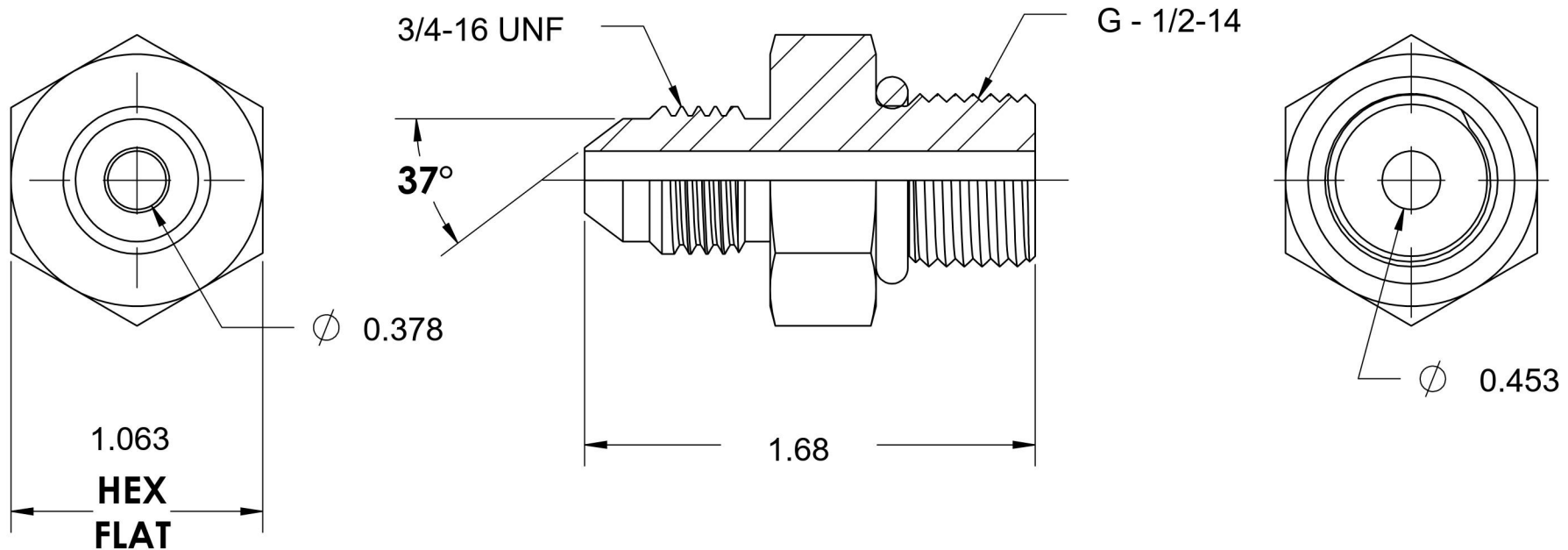
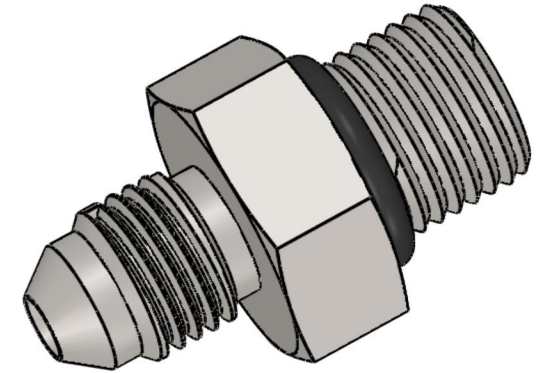

6701 Cochran Road
Solon, Ohio 44139
Phone: (440) 248-1880
Toll Free: 1-888-331-1523

Temperature Rating	Material	Industry Standards	Series
-40°F to 250°F	C1045/12L14 Steel	SAE J514, JIS B2351 ASTM B633	7002-JIS B2351
Pressure Rating	Finish		Series Description
5000 psi	Trivalent Zinc		SAE J514 37° Flare Male BSPP (JIS B2351) Port Connector