

1800-24-20

Steel, SAE J514 37° Flare Code 62 Flange Adapter, 1-1/2" Male JIC x 1-1/4" Split Flange Head

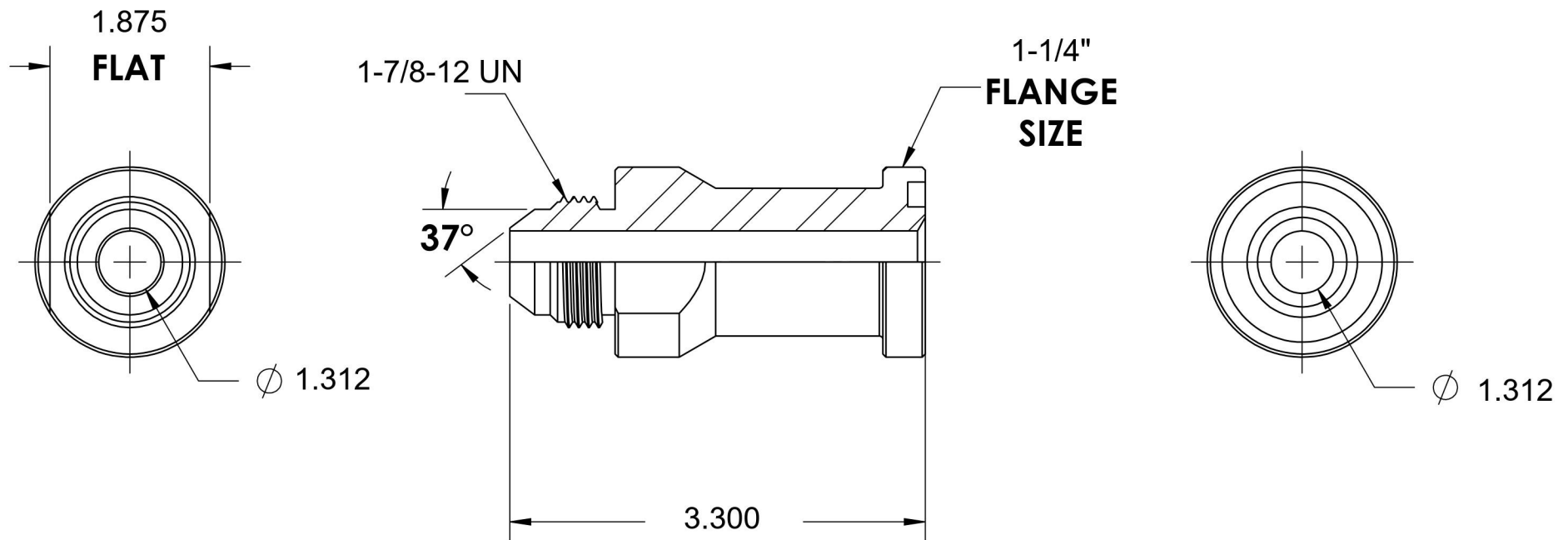

6701 Cochran Road
Solon, Ohio 44139
Phone: (440) 248-1880
Toll Free: 1-888-331-1523

Temperature Rating

-65°F to 500°F

Pressure Rating

3000 psi

Material

C1045/12L14 Steel

Finish

Trivalent Zinc

Industry Standards

SAE J518 Code 62, SAE J514
ASTM B633

Series

1800

Series Description

SAE J514 37° Flare
Code 62 Flange Adapter