

7009-06-16

Steel, SAE J514 37° Flare Male Komatsu Adapter, 3/8" Male JIC x M16X1.5 Male Komatsu

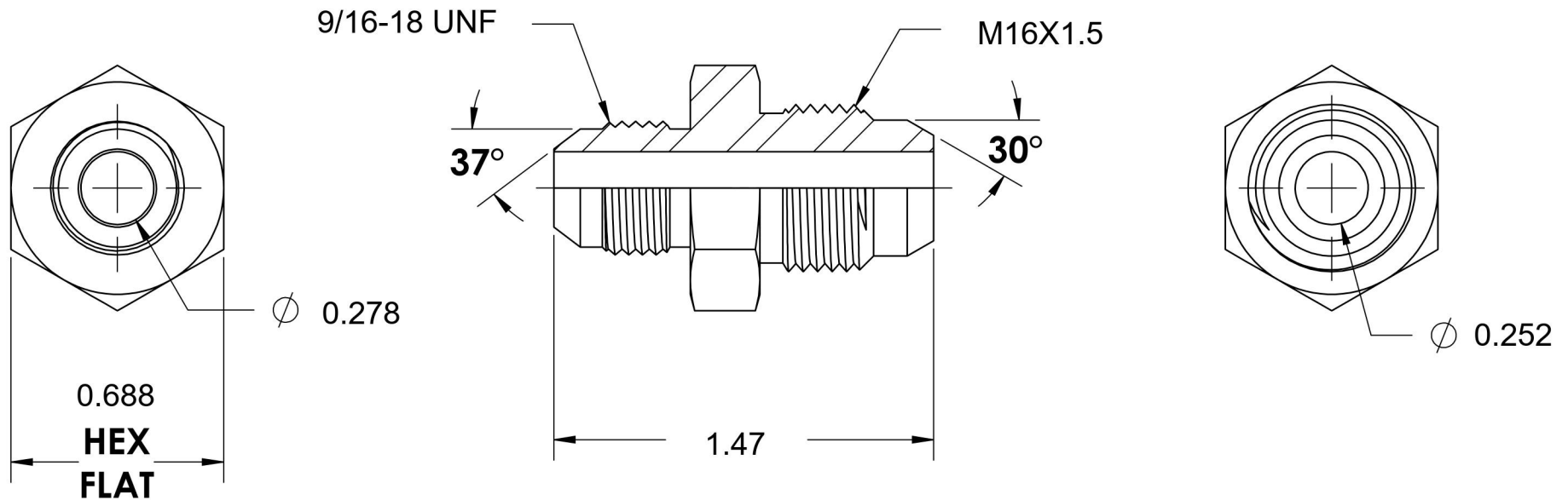
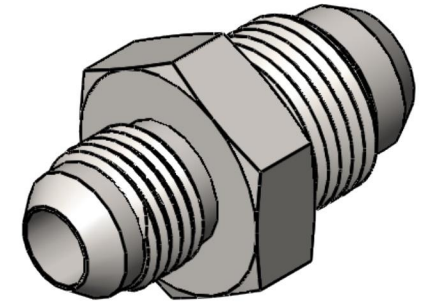

6701 Cochran Road
Solon, Ohio 44139
Phone: (440) 248-1880
Toll Free: 1-888-331-1523

Temperature Rating	Material	Industry Standards	Series
-65°F to 500°F	C1045 / 12L14 Steel	SAE J514, ASTM B633	7009
Pressure Rating	Finish	Komatsu Standard	Series Description
4000 psi	Trivalent Zinc		SAE J514 37° Flare Male Komatsu Adapter