

2700-LN-12-12

Steel, SAE J514 37° Flare Bulkhead With Lock Nut, 3/4" Male JIC x 3/4" Male JIC

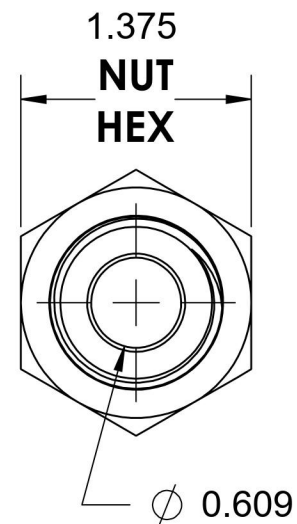
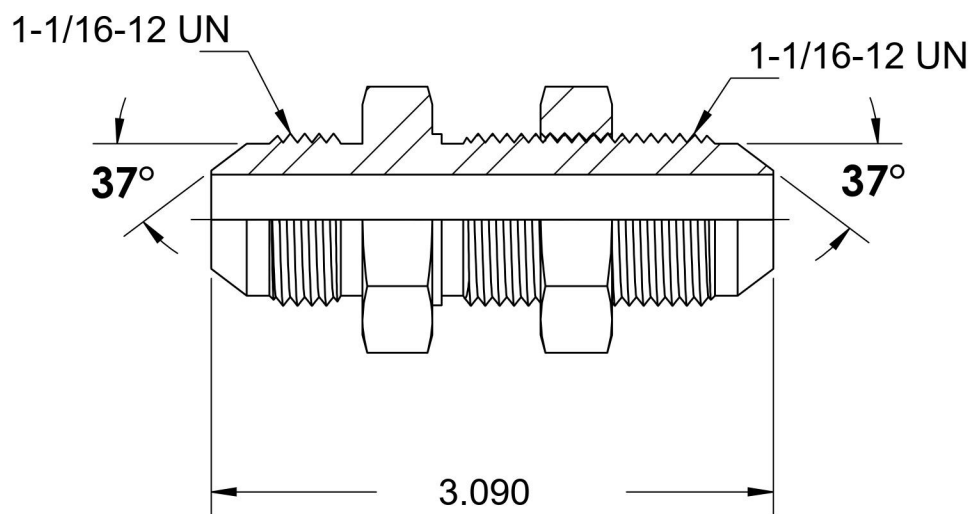
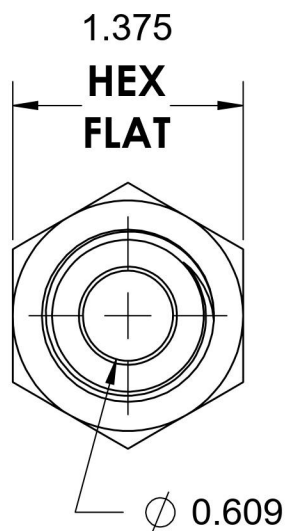
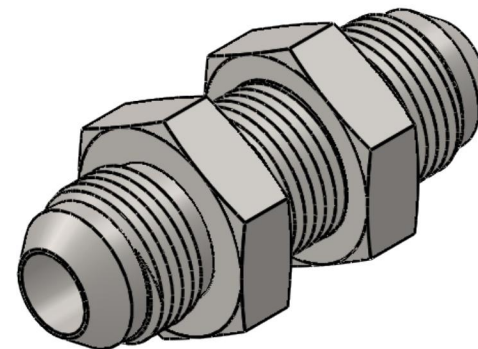

6701 Cochran Road
Solon, Ohio 44139
Phone: (440) 248-1880
Toll Free: 1-888-331-1523

Temperature Rating	Material	Industry Standards	Series
-65°F to 500°F	C1045/12L14 Steel	SAE J514, ASTM B633	2700-LN
Pressure Rating	Finish		Series Description
5000 psi	Trivalent Zinc		SAE J514 37° Flare Bulkhead With Lock Nut