

# 9022-12-04

Steel, ISO 1179 BSPP Port/Line Union, 3/4-14 Male BSPP 60° Line/Port x 1/4-19 Male BSPP 60° Line/Port

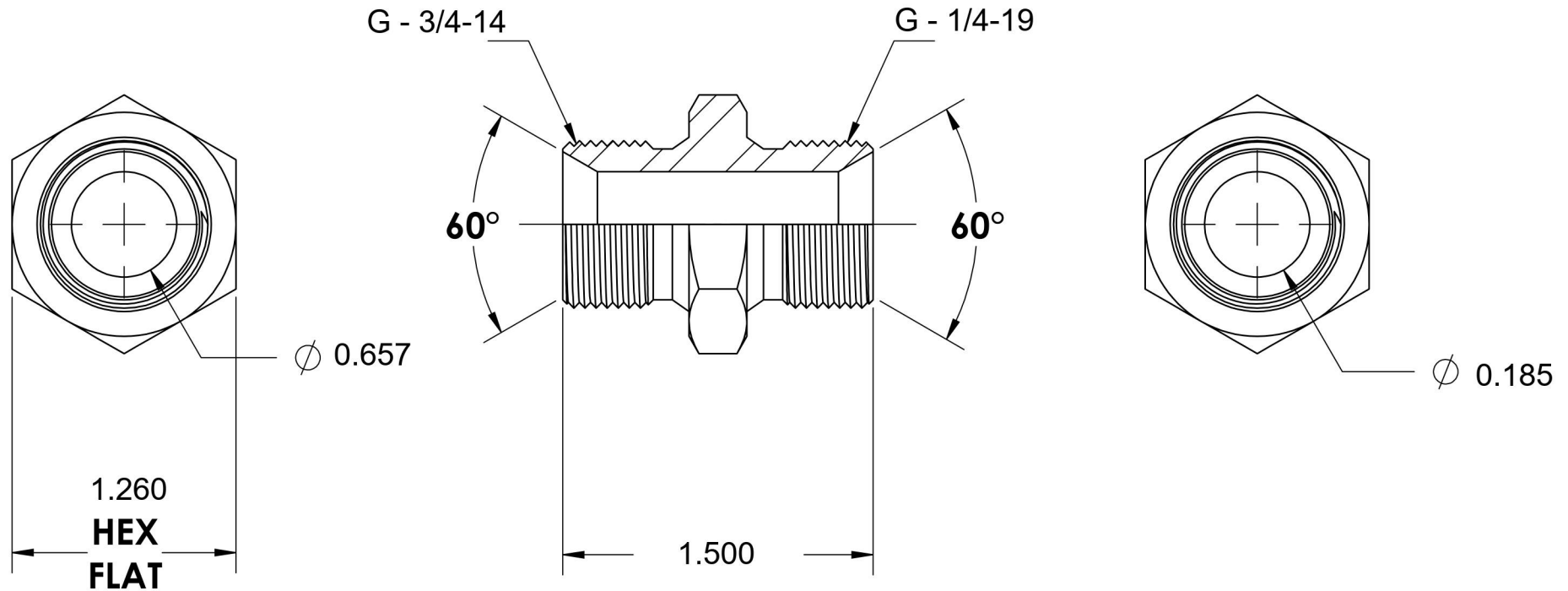
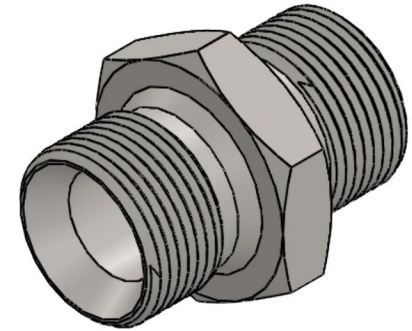

6701 Cochran Road  
Solon, Ohio 44139  
Phone: (440) 248-1880  
Toll Free: 1-888-331-1523

**Temperature Rating**

-65°F to 500°F

**Pressure Rating**

2900 psi

**Material**

C1045/12L14 Steel

**Finish**

Trivalent Zinc

**Industry Standards**

ISO 1179, ISO 8434-6  
ASTM B633

**Series**

9022

**Series Description**

ISO 1179 BSPP  
Port/Line Union