

1704-08-08-FG

Steel, SAE J514 37° Flare 90° Code 61 Flange Forged Elbow, 1/2" Male JIC x 1/2" Split Flange Head

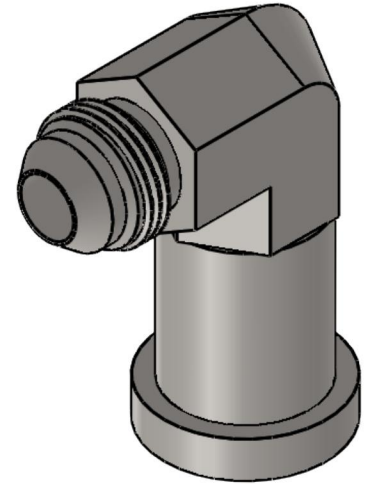
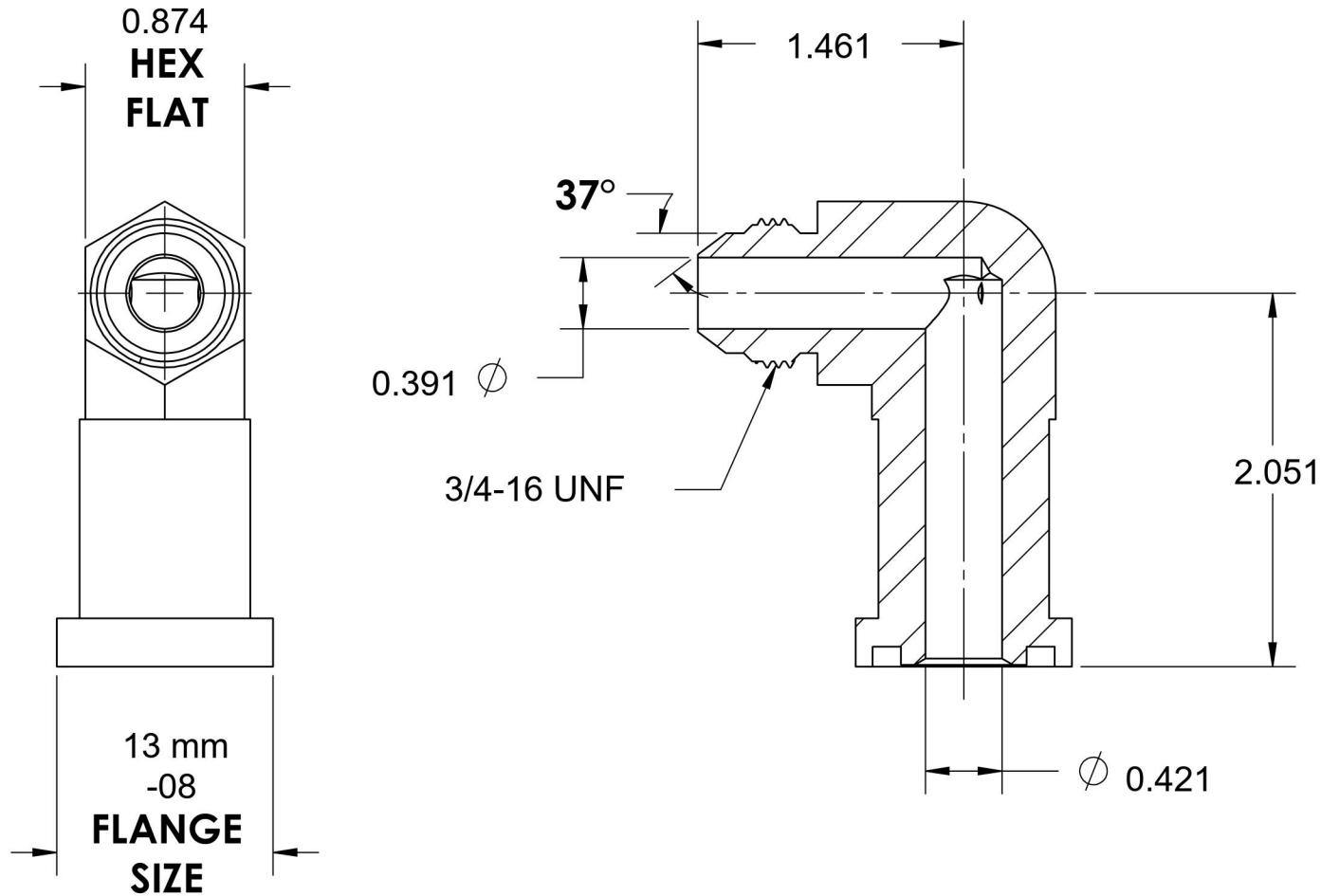

6701 Cochran Road
Solon, Ohio 44139
Phone: (440) 248-1880
Toll Free: 1-888-331-1523

Temperature Rating	Material	Industry Standards	Series
-65°F to 500°F	C1045 Steel	SAE J518 Code 61 SAE J514, ASTM B633	1704-FG
Pressure Rating	Finish		Series Description
5000psi	Trivalent Zinc		SAE J514 37° Flare 90° Code 61 Flange Forged Elbow