

7009-F-12-30

Steel, SAE J514 37° Flare Female Komatsu Adapter, 3/4" Male JIC x M30X1.5 Female Komatsu

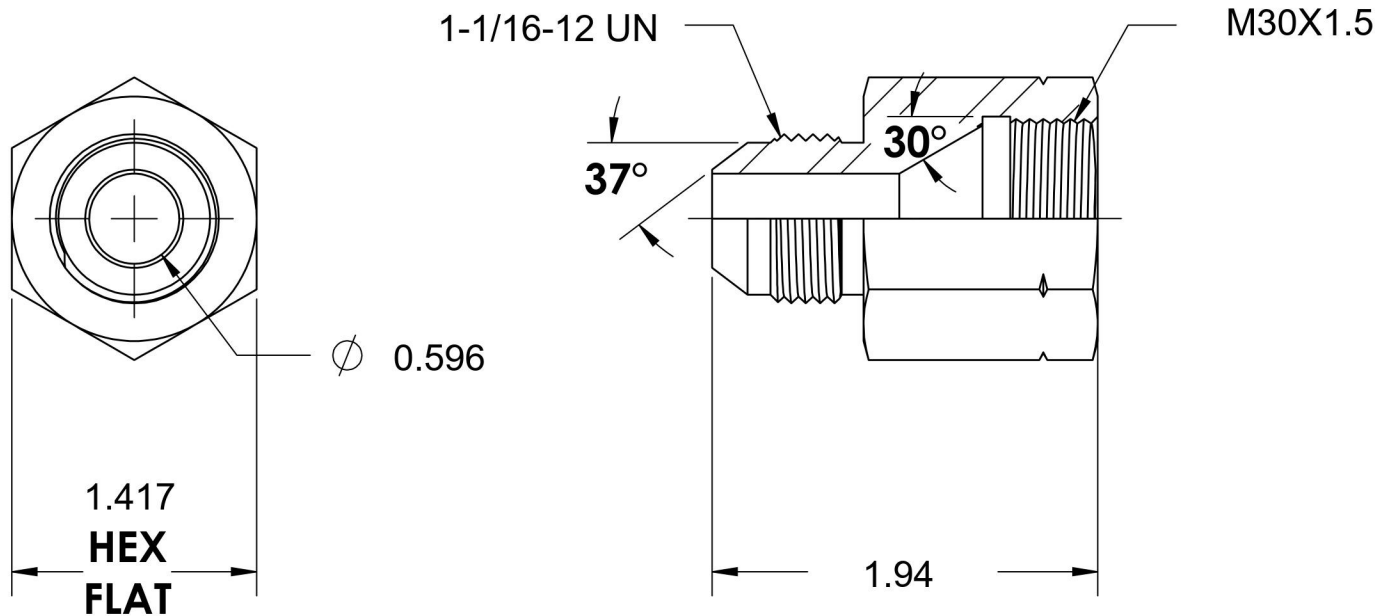
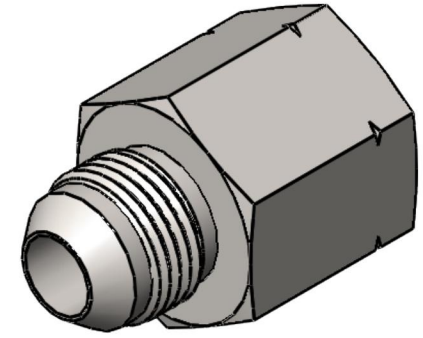

6701 Cochran Road
Solon, Ohio 44139
Phone: (440) 248-1880
Toll Free: 1-888-331-1523

Temperature Rating

-65°F to 500°F

Pressure Rating

4000 psi

Material

C1045 / 12L14 Steel

Finish

Trivalent Zinc

Industry Standards

SAE J514, ASTM B633
Komatsu Standard

Series

7009-F

Series Description

SAE J514 37° Flare
Female Komatsu Adapter