

5652-06-06-06-06-B

Brass, SAE J514 Pipe Female Cross, 3/8" Female NPTF

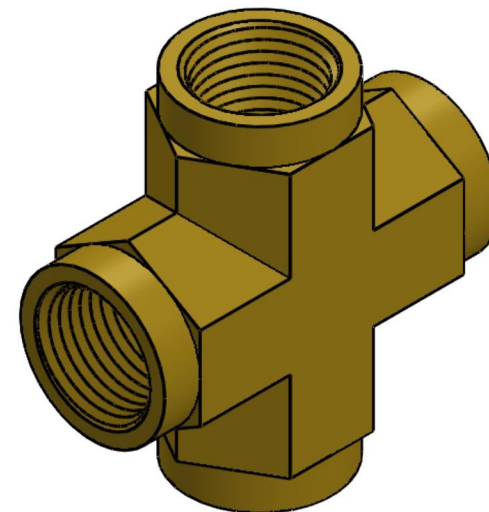
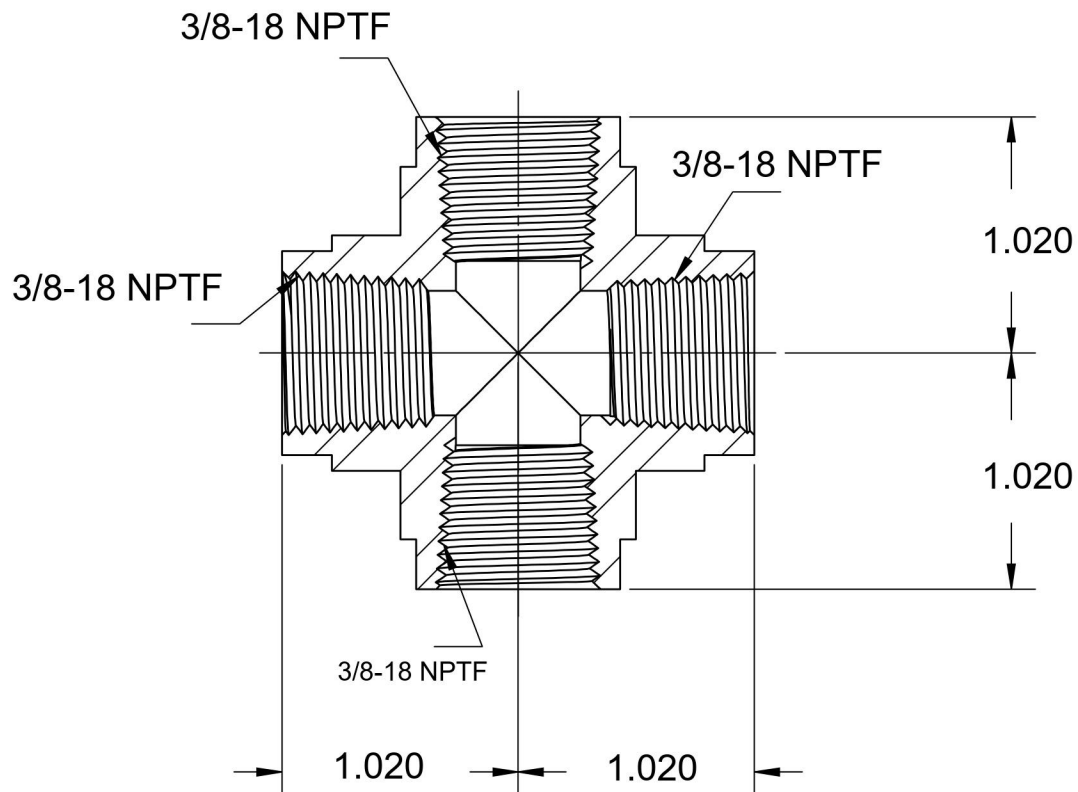
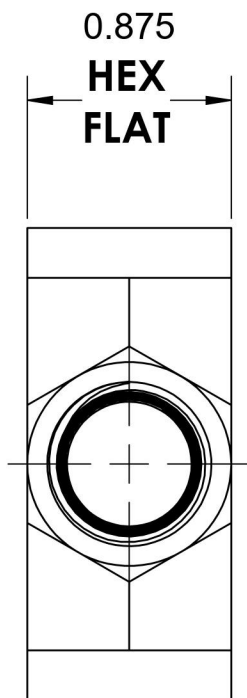

6701 Cochran Road
Solon, Ohio 44139
Phone: (440) 248-1880
Toll Free: 1-888-331-1523

Temperature Rating	Material	Industry Standards	Series
-425°F to 1200°F	C37700 Brass	SAE J514, SAE J476	5652-FG
Pressure Rating	Finish		Series Description
4500 psi	Natural Finish		SAE J514 Pipe Female Cross