

6602-32-32-32-SS

Stainless Steel, SAE J514 37° Flare Swivel Run Tee, 2" Male JIC x 2" Female JIC Swivel x 2" Male JIC

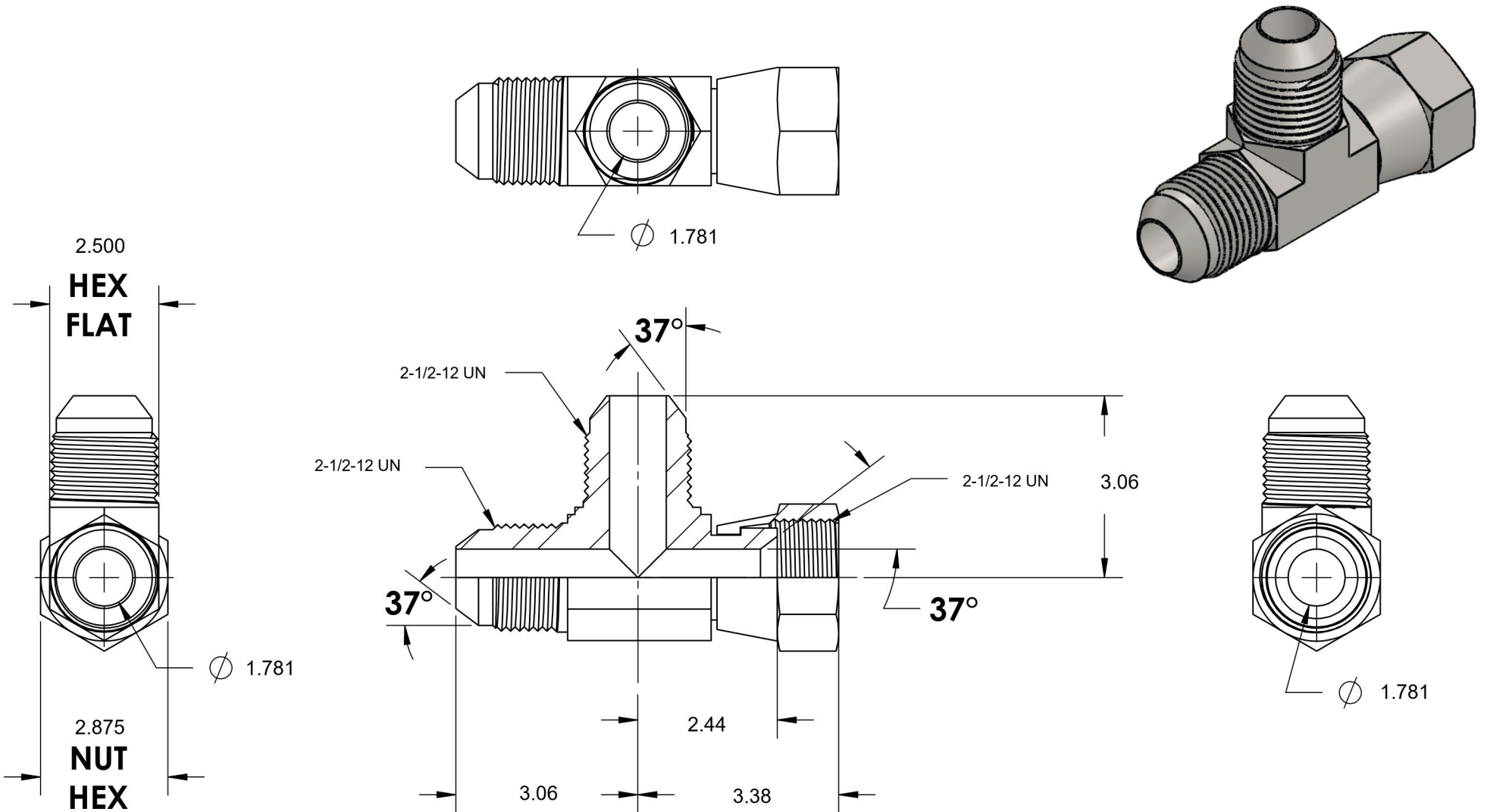

6701 Cochran Road
Solon, Ohio 44139
Phone: (440) 248-1880
Toll Free: 1-888-331-1523

Temperature Rating -425°F to 1200°F	Material 316/316L Stainless Steel	Industry Standards SAE J514	Series 6602-SS
Pressure Rating 2000 psi	Finish Passivated		Series Description SAE J514 37° Flare Swivel Run Tee