

6801-05-05-NWO-FG-VITON

Steel, SAE J514 37° Flare 90° Adjustable Port Elbow, 5/16" Male JIC x 1/2-20 Male Adjustable ORB, FKM Seal

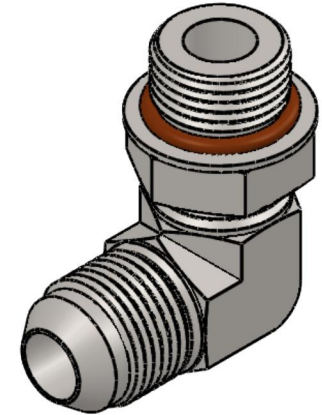
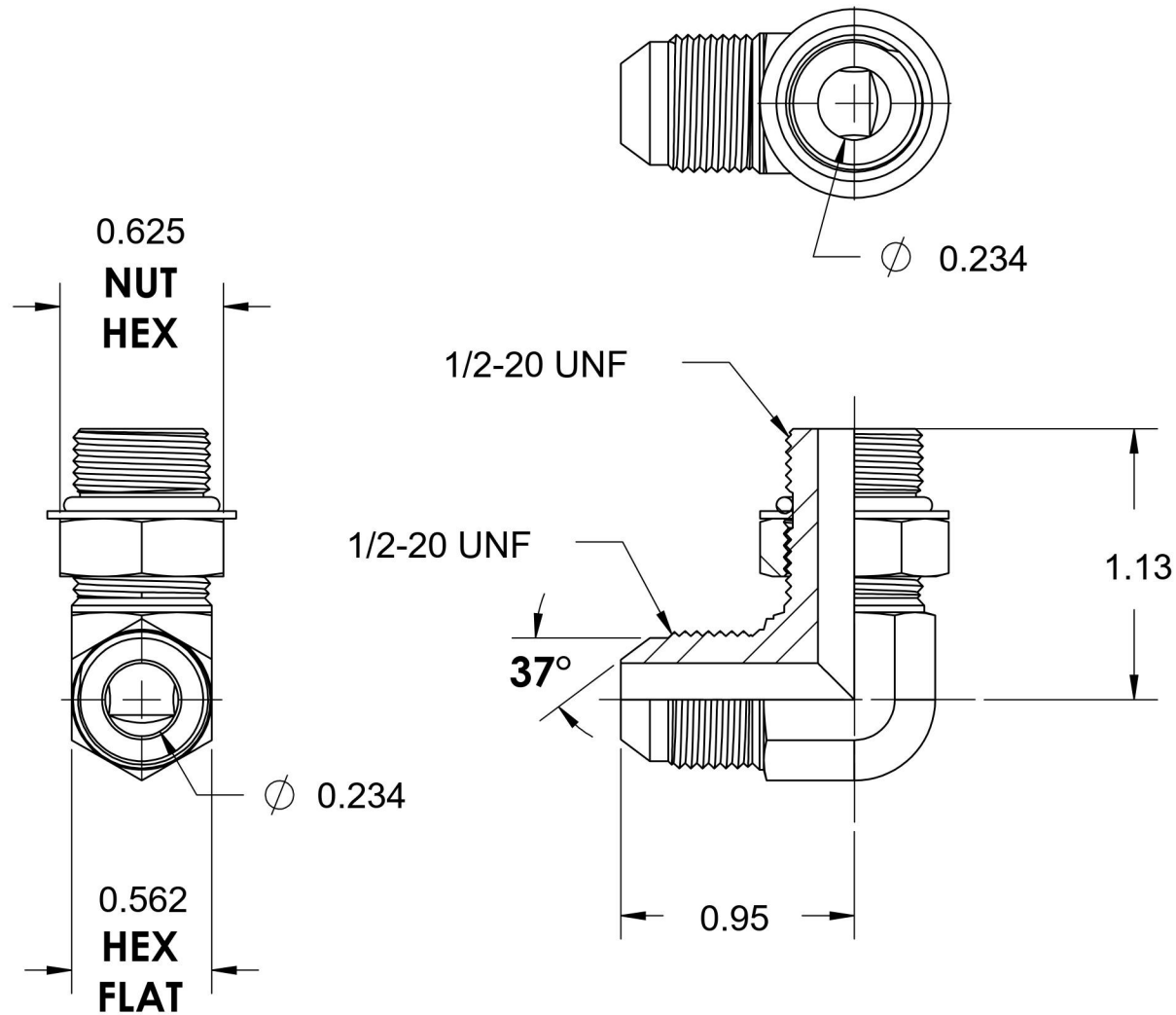

6701 Cochran Road
Solon, Ohio 44139
Phone: (440) 248-1880
Toll Free: 1-888-331-1523

Temperature Rating	Material	Industry Standards	Series
-15°F / 400°F	C1045 Steel	SAE J514, SAE J1926-3 ASTM B633	6801-NWO-FG-VITON
Pressure Rating	Finish		Series Description
6000 psi	Trivalent Zinc		SAE J514 37° Flare 90° Adjustable Port Elbow