

# C0319-02

Steel, SAE J514 Flareless Tube Ferrule, 1/8" Flareless Bite Type Sleeve Type A

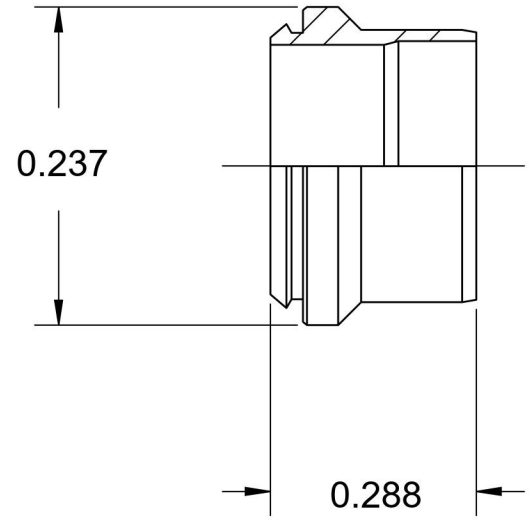
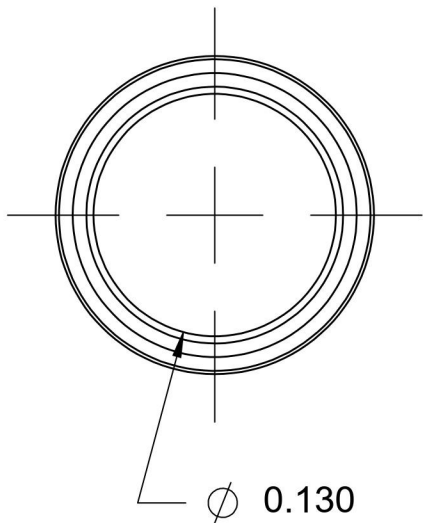

6701 Cochran Road  
Solon, Ohio 44139  
Phone: (440) 248-1880  
Toll Free: 1-888-331-1523

<b>Temperature Rating</b> -65°F to 500°F	<b>Material</b> Low Carbon Steel	<b>Industry Standards</b> SAE J514, AMS 2769 MIL-DTL-16236, ASTM-F1137	<b>Series</b> C0319
<b>Pressure Rating</b> Not Available	<b>Finish</b> Zinc Phosphate Heat Treat per AMS 2769		<b>Series Description</b> SAE J514 Flareless Tube Ferrule