

2603-06-06-06-B

Brass, SAE J514 37° Flare Union Tee, 3/8" Male JIC

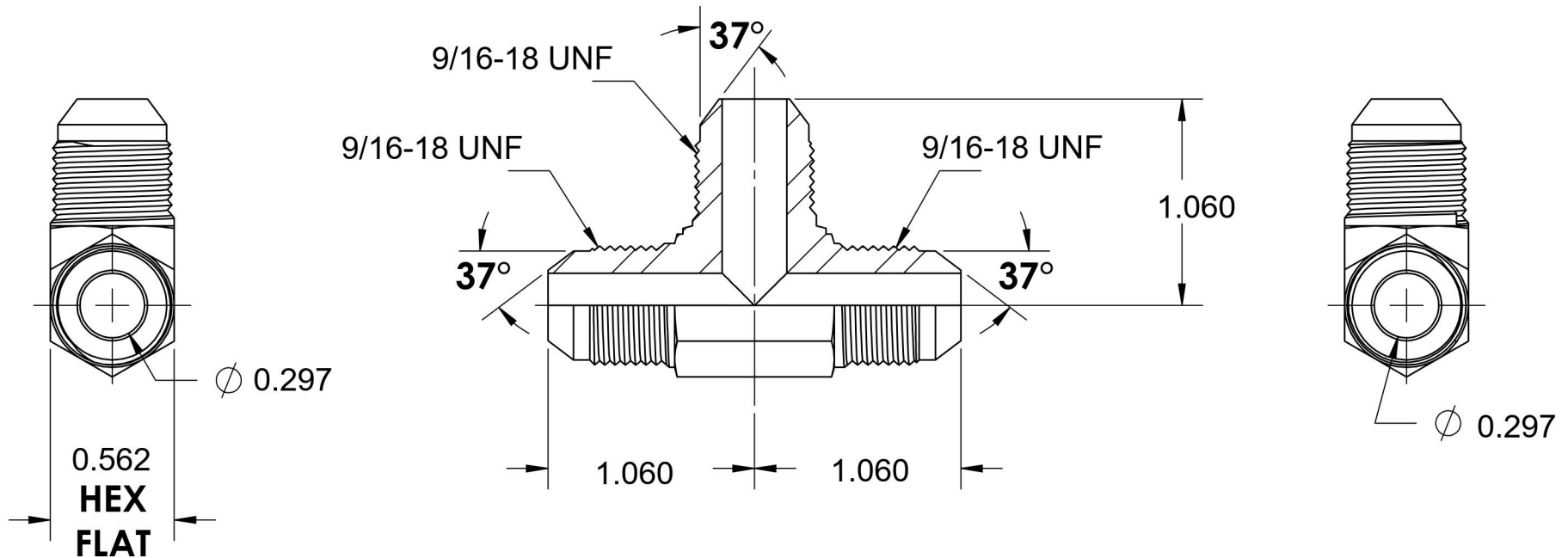
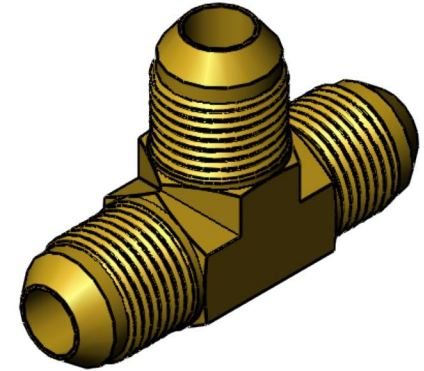
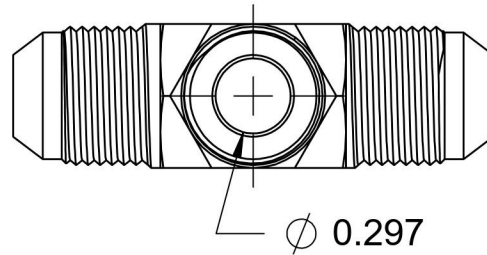

6701 Cochran Road
Solon, Ohio 44139
Phone: (440) 248-1880
Toll Free: 1-888-331-1523

Temperature Rating	Material	Industry Standards	Series
-325°F to 400°F	CA37700 Brass	SAE J514	2603-B
Pressure Rating	Finish	Series Description	
3300 psi	Natural Finish	SAE J514 37° Flare Union Tee	