

2406-20-12

Steel, SAE J514 37° Flare Reducer, 1-1/4" Female JIC x 3/4" Male JIC

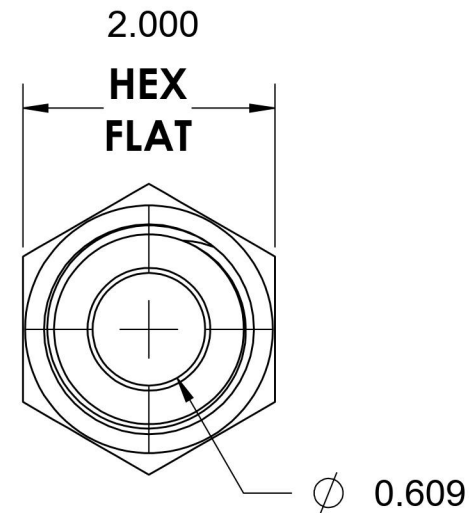
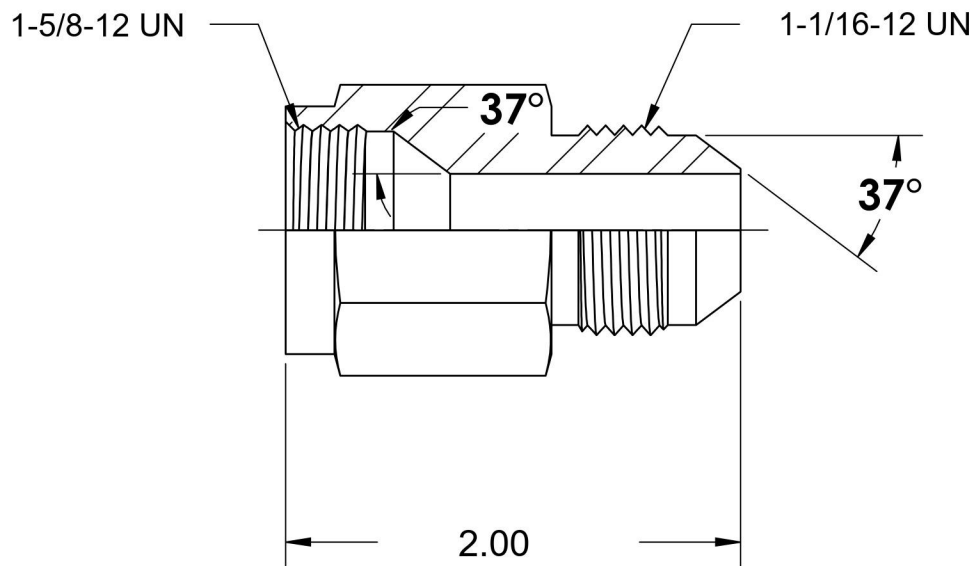

6701 Cochran Road
Solon, Ohio 44139
Phone: (440) 248-1880
Toll Free: 1-888-331-1523

Temperature Rating

-65°F to 500°F

Material

C1045/12L14 Steel

Industry Standards

SAE J514, ASTM B633

Series

2406

Pressure Rating

4000 psi

Finish

Trivalent Zinc

Series Description

SAE J514 37° Flare Reducer