

2405-16-20

Steel, SAE J514 Flared Tube Female Connector, 1" Male JIC x 1-1/4" Female NPTF

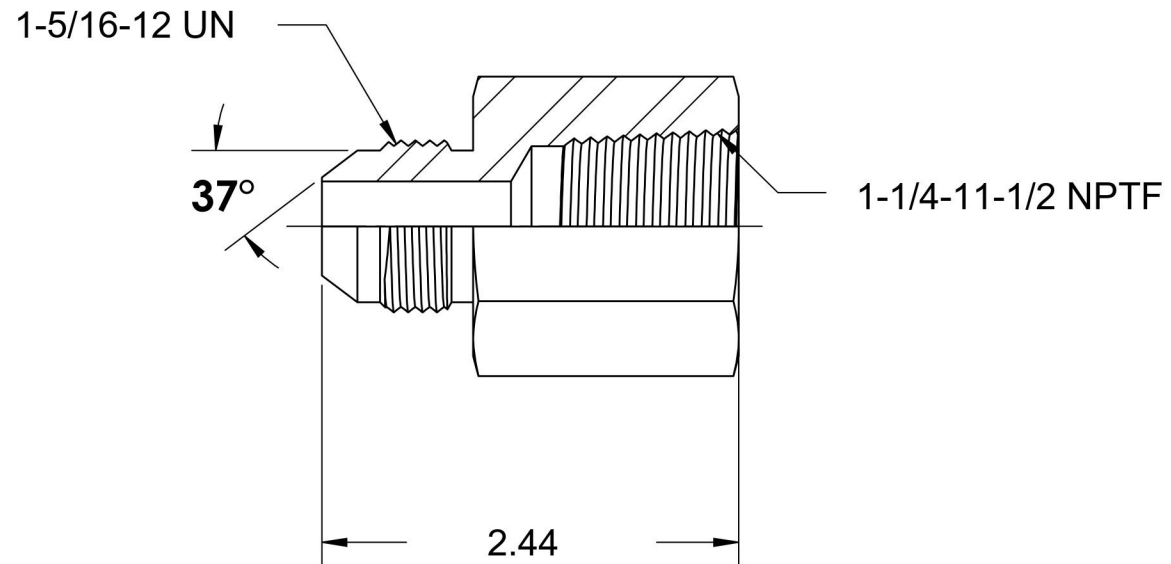
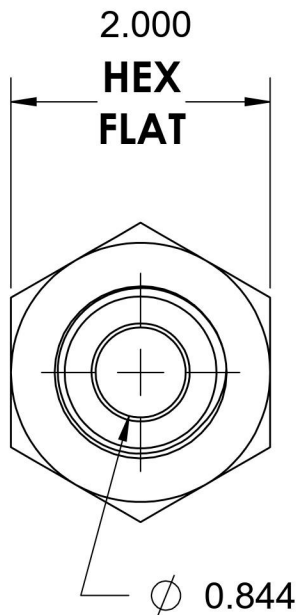

6701 Cochran Road
Solon, Ohio 44139
Phone: (440) 248-1880
Toll Free: 1-888-331-1523

Temperature Rating

-65°F to 500°F

Pressure Rating

2500 psi

Material

C1045/12L14 Steel

Finish

Trivalent Zinc

Industry Standards

SAE J514 , SAE J476
ASTM B633

Series

2405

Series Description

SAE J514 Flared Tube
Female Connector