

6902-10-08-NWO-FG

Steel, SAE J514 NPSM Swivel 45° Adjustable Port Elbow, 7/8-14 Male Adjustable ORB x 1/2" Female NPSM Swivel

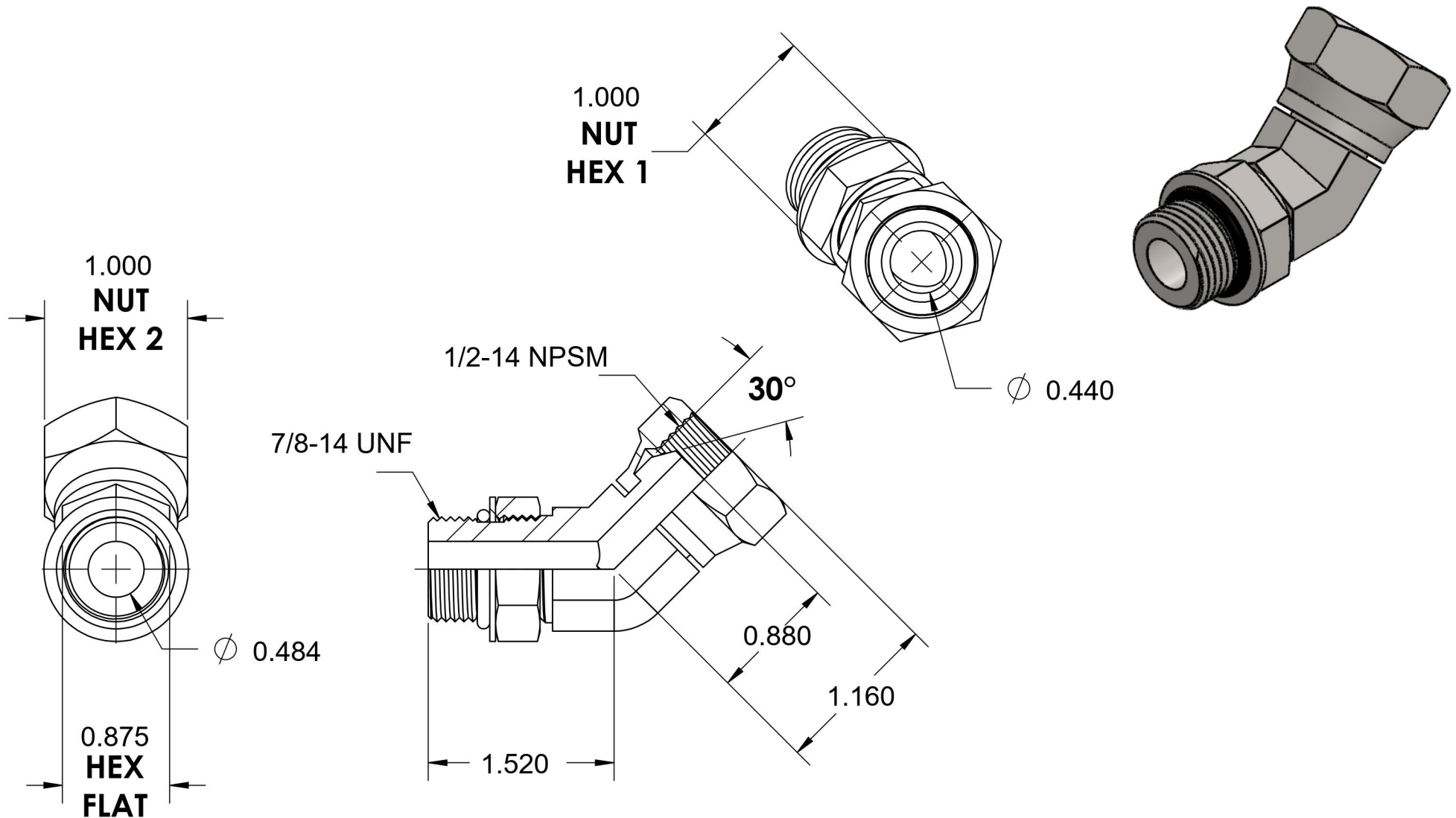

6701 Cochran Road
Solon, Ohio 44139
Phone: (440) 248-1880
Toll Free: 1-888-331-1523

Temperature Rating	Material	Industry Standards	Series
-40°F to 250°F	C1045 Steel	SAE J514, SAE J1926-3 SAE J515, ASTM B633	6902-NWO-FG
Pressure Rating	Finish		Series Description
5000psi	Trivalent Zinc		SAE J514 NPSM Swivel 45° Adjustable Port Elbow