

FS6804-06-06-NWO-SS

Stainless Steel, SAE J1453 O-Ring Face Seal Adjustable Port Run Tee, 3/8" Male ORFS x 9/16-18 Male Adjustable ORB x 3/8" Male ORFS

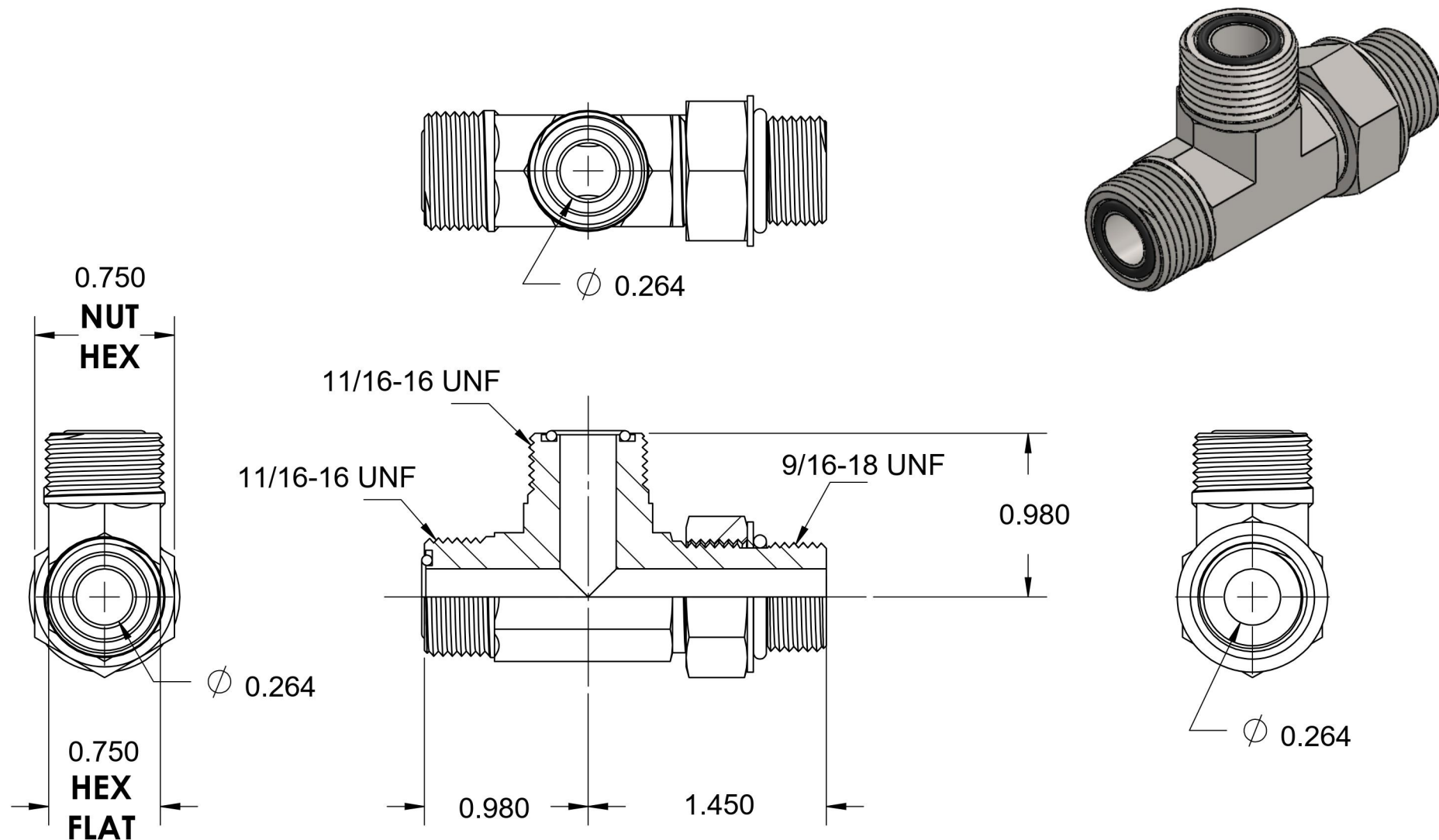

6701 Cochran Road
Solon, Ohio 44139
Phone: (440) 248-1880
Toll Free: 1-888-331-1523

Temperature Rating	Material	Industry Standards	Series
-40°F to 250°F	316/316L Stainless Steel	SAE J1453, SAE J1926-2 SAE J515	FS6804-NWO-SS
Pressure Rating	Finish		Series Description
6000 psi	Passivated		SAE J1453 O-Ring Face Seal Adjustable Port Run Tee