

# C6400-12-16-O

Steel, SAE J514 Flareless Tube Port Connector, 3/4" Flareless Bite Type x 1-5/16-12 Male ORB

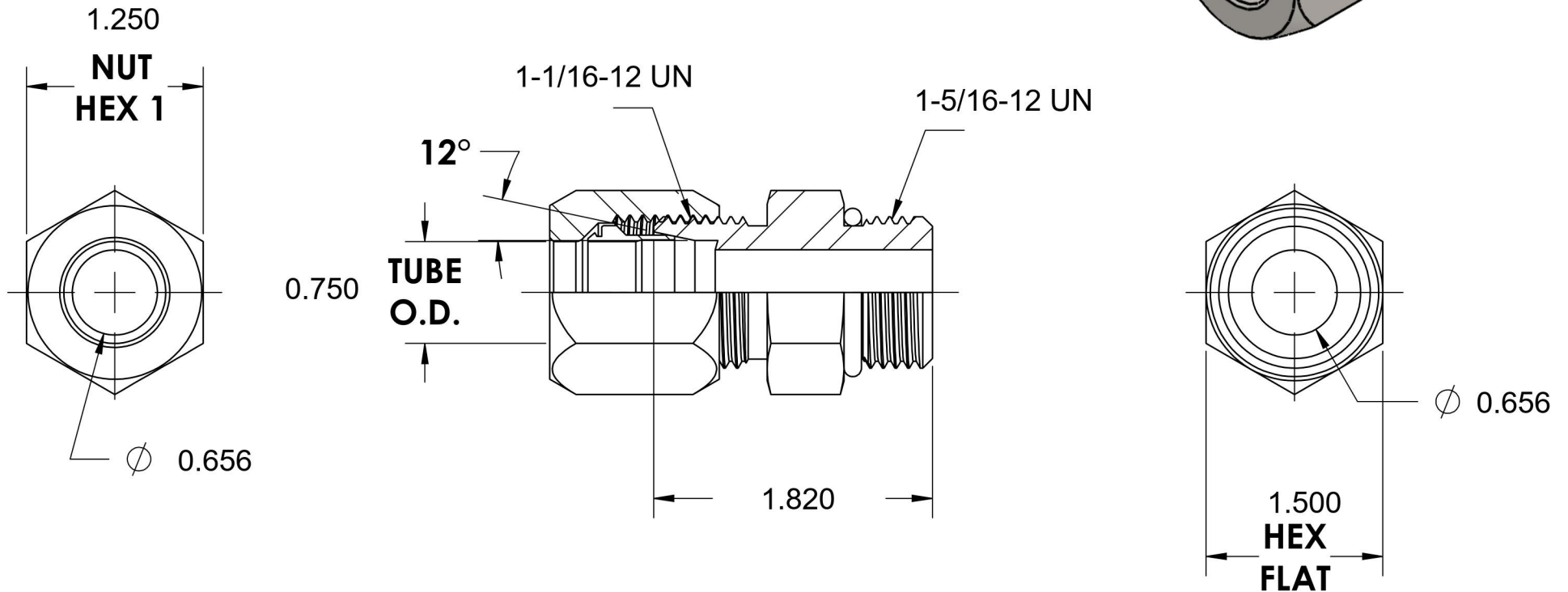
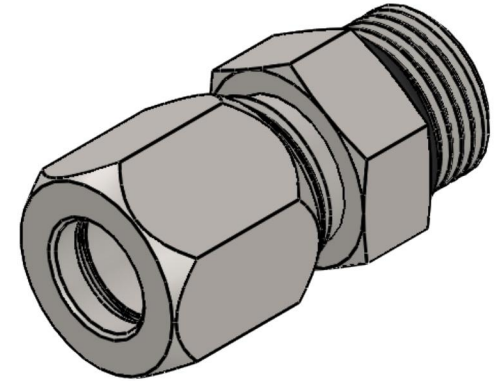

6701 Cochran Road  
Solon, Ohio 44139  
Phone: (440) 248-1880  
Toll Free: 1-888-331-1523

**Temperature Rating**

-40°F to 250°F

**Pressure Rating**

4000psi

**Material**

C1045 Steel

**Finish**

Trivalent Zinc

**Industry Standards**

SAE J514, SAE J1926  
ASTM B633

**Series**

C6400-O

**Series Description**

SAE J514 Flareless Tube Port Connector