

9522-P-08-SS

Stainless Steel, ISO 1179 BSPP Hex Head Port Plug, 1/2-14 Male BSPP 60° Line/Port

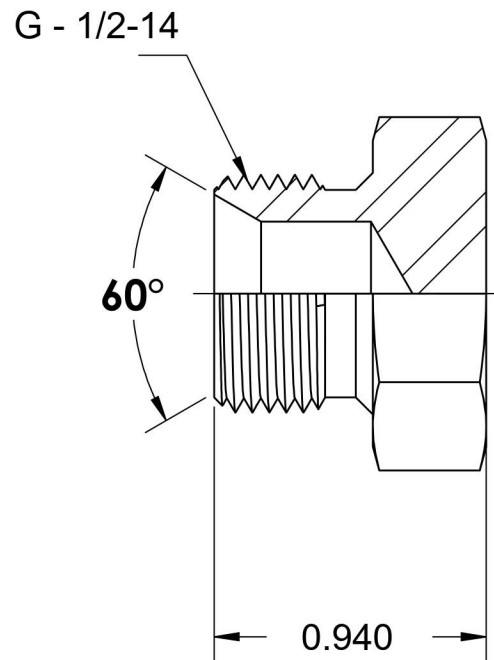
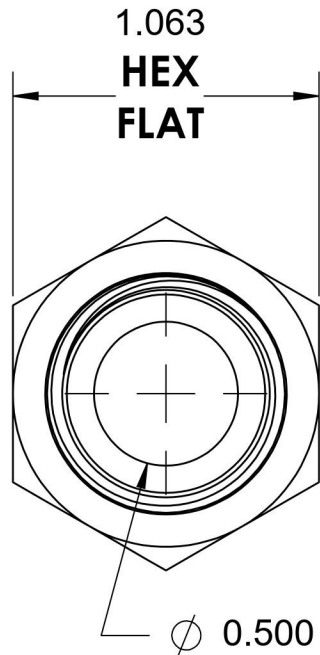
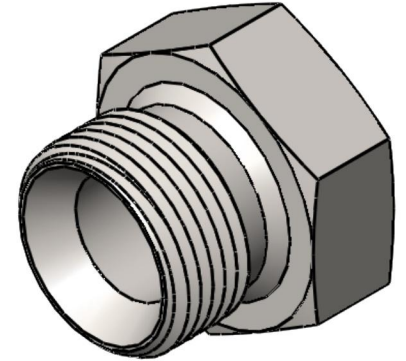

6701 Cochran Road
Solon, Ohio 44139
Phone: (440) 248-1880
Toll Free: 1-888-331-1523

Temperature Rating	Material	Industry Standards	Series
-425°F to 1200°F	316/316L Stainless Steel	ISO 1179	9522-P-SS
Pressure Rating	Finish		Series Description
2900 psi	Passivated		ISO 1179 BSPP Hex Head Port Plug