

6802-05-05-NWO-SS

Stainless Steel, SAE J514 37° Flare 45° Adjustable Port Elbow, 5/16" Male JIC x 1/2-20 Male Adjustable ORB

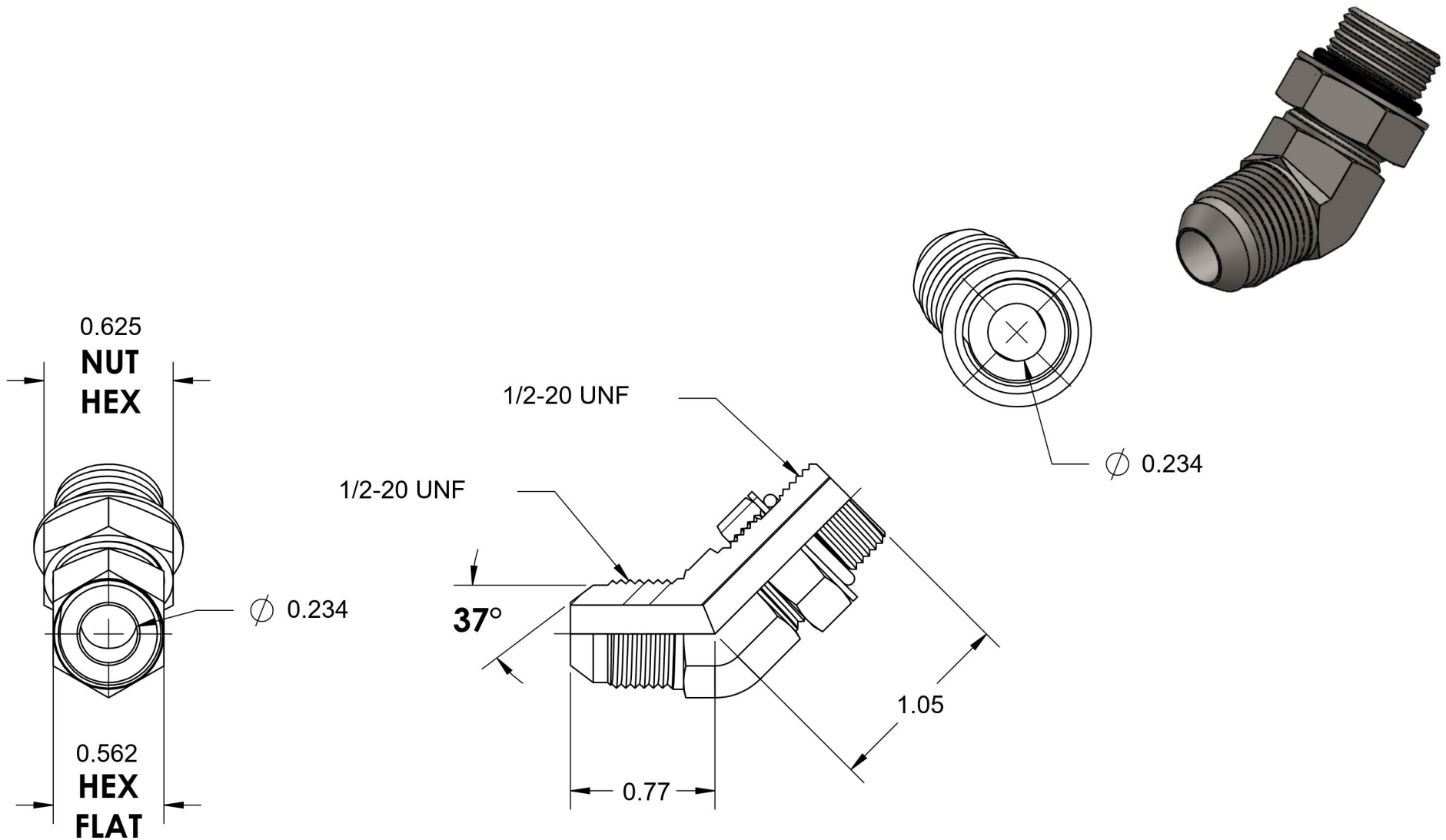

6701 Cochran Road
Solon, Ohio 44139
Phone: (440) 248-1880
Toll Free: 1-888-331-1523

Temperature Rating	Material	Industry Standards	Series
-40°F to 250°F	316/316L Stainless Steel	SAE J514, SAE J1926-3 SAE J515	6802-NWO-SS
Pressure Rating	Finish		Series Description
5400 psi	Passivated		SAE J514 37° Flare 45° Adjustable Port Elbow