

# 6801-10-06-NWO-FG-VITON

Steel, SAE J514 37° Flare 90° Adjustable Port Elbow, 5/8" Male JIC x 9/16-18 Male Adjustable ORB, FKM Seal

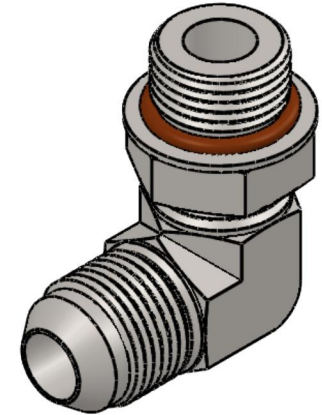
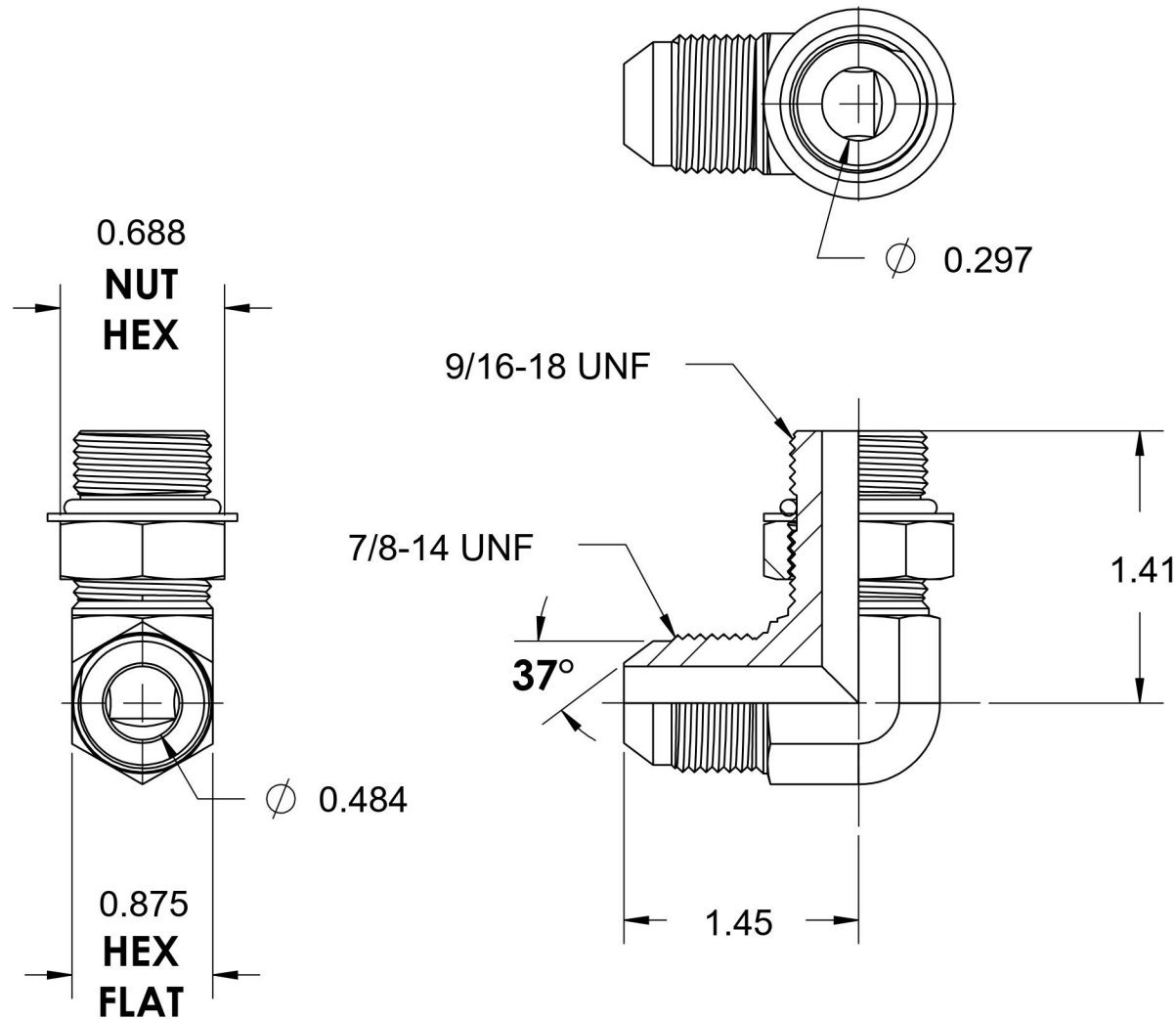

6701 Cochran Road  
Solon, Ohio 44139  
Phone: (440) 248-1880  
Toll Free: 1-888-331-1523

<b>Temperature Rating</b>	<b>Material</b>	<b>Industry Standards</b>	<b>Series</b>
-15°F / 400°F	C1045 Steel	SAE J514, SAE J1926-3 ASTM B633	6801-NWO-FG-VITON
<b>Pressure Rating</b>	<b>Finish</b>		<b>Series Description</b>
5000 psi	Trivalent Zinc		SAE J514 37° Flare 90° Adjustable Port Elbow