

# 1501-24-24-FG

Steel, SAE J514 NPSM Swivel 90° Male Elbow, 1-1/2" Male NPTF 30° x 1-1/2" Female NPSM Swivel

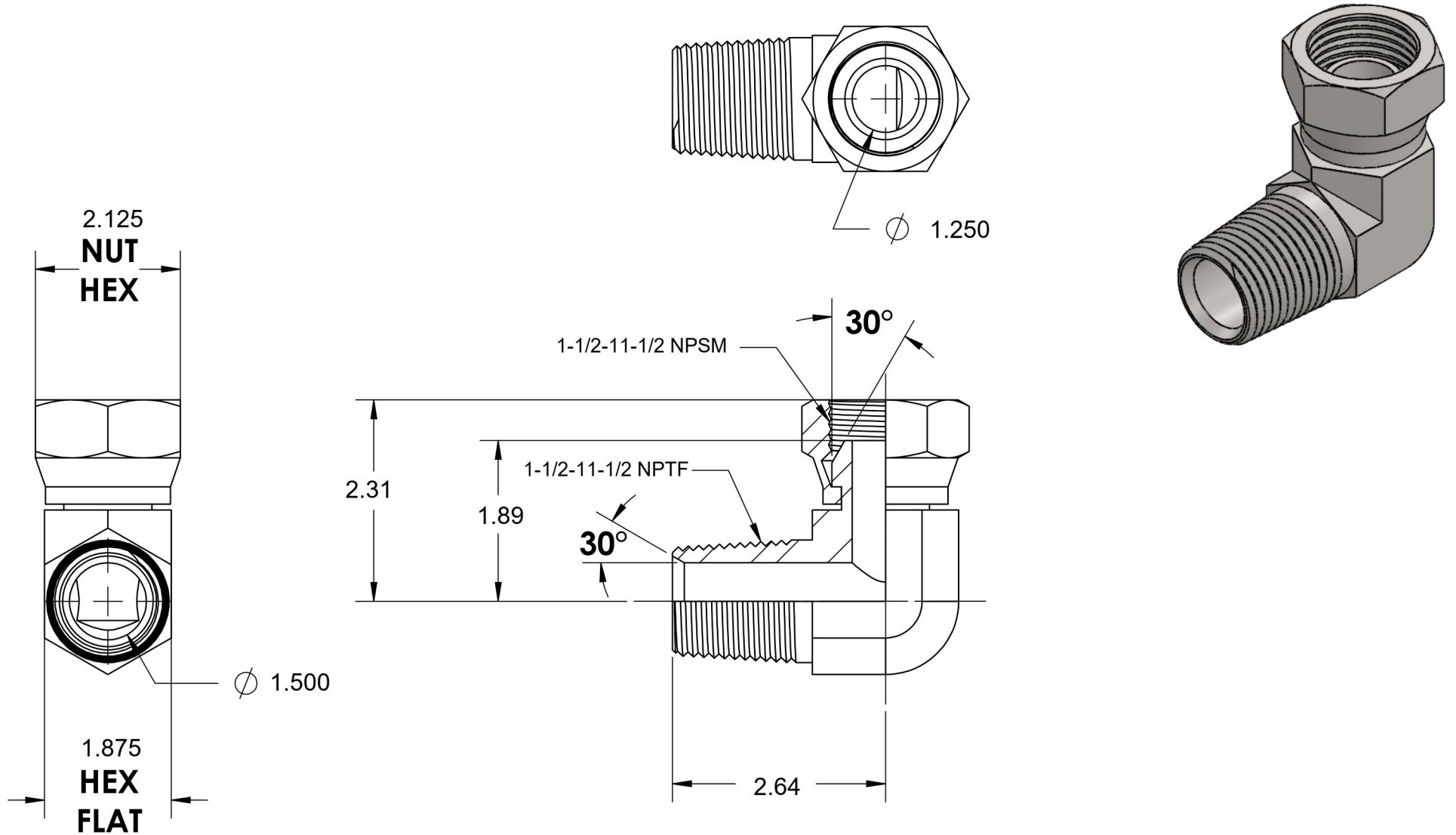

6701 Cochran Road  
Solon, Ohio 44139  
Phone: (440) 248-1880  
Toll Free: 1-888-331-1523

|                           |                 |                                 |  |
|---------------------------|-----------------|---------------------------------|--|
| <b>Temperature Rating</b> | <b>Material</b> | <b>Industry Standards</b>       | <b>Series</b>                          |
| -65°F to 500°F            | C1045 Steel     | SAE J514, SAE J476<br>ASTM B633 | 1501-FG                                |
| <b>Pressure Rating</b>    | <b>Finish</b>   |                                 | <b>Series Description</b>              |
| 2000 psi                  | Trivalent Zinc  |                                 | SAE J514 NPSM Swivel<br>90° Male Elbow |