

7022-10-06-BS

Steel, SAE J514 37° Flare Swivel BSPP Type (D) Bonded Seal Port/Line Connector, 5/8" Female JIC Swivel x 3/8-19 Male BSPP 60° Line/Port

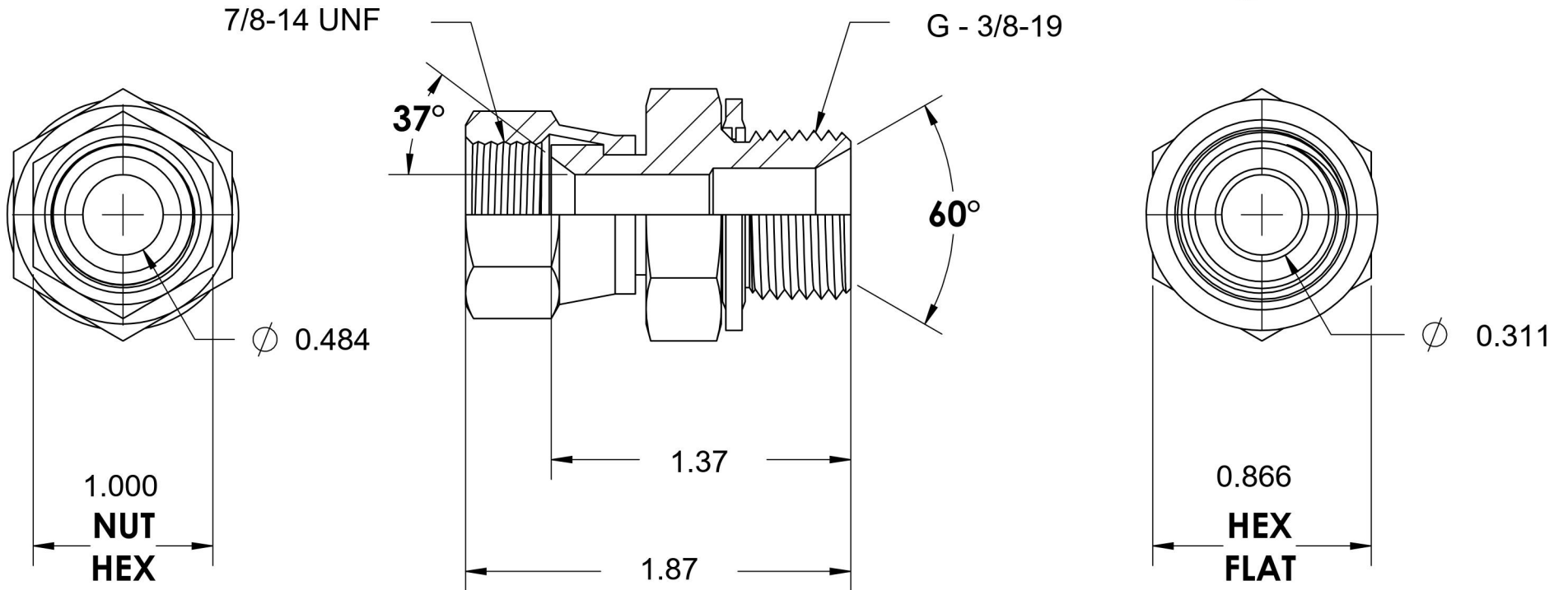

6701 Cochran Road
Solon, Ohio 44139
Phone: (440) 248-1880
Toll Free: 1-888-331-1523

Temperature Rating -40°F to 250°F	Material C1045 / 12L14 Steel	Industry Standards SAE J514, ISO 1179	Series 7022-BS
Pressure Rating 5000 psi	Finish Trivalent Zinc	ISO 8434-6, ASTM B633	Series Description SAE J514 37° Flare Swivel BSPP Type (D) Bonded Seal Port/Line Connector