

D0319-16

Steel, DIN 2353 Double Bite Cutting Ring, 16mm Tube OD

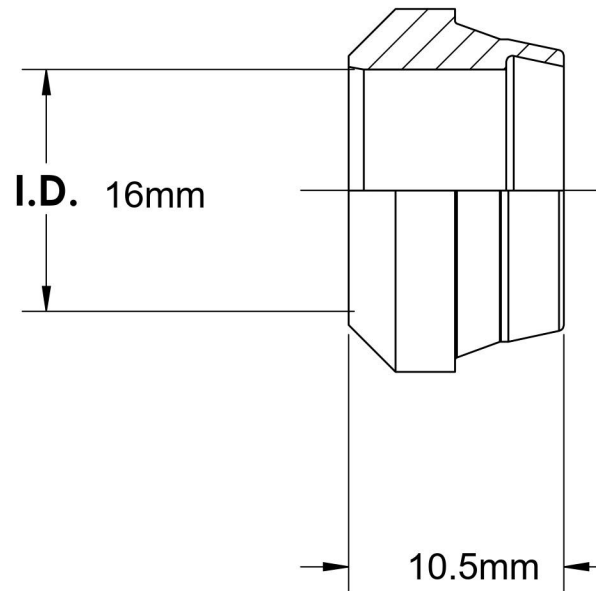
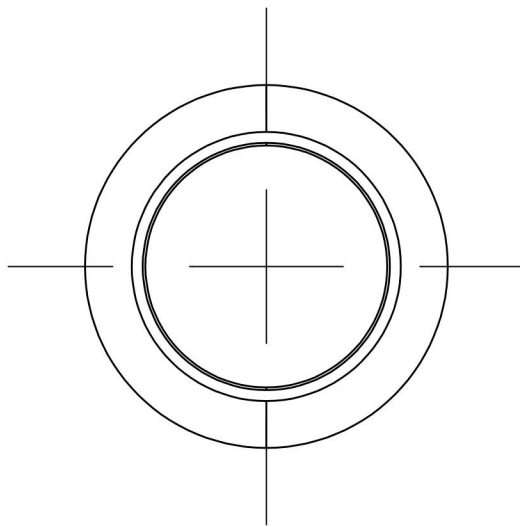
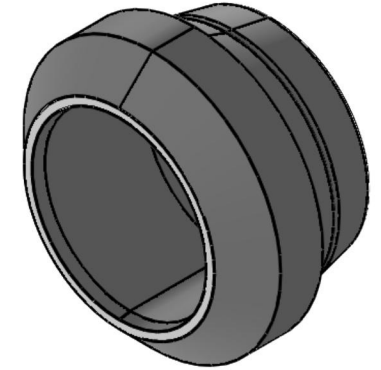

6701 Cochran Road
Solon, Ohio 44139
Phone: (440) 248-1880
Toll Free: 1-888-331-1523

Temperature Rating -65°F to 500°F	Material Carbon Steel	Industry Standards DIN 2353, ISO 8434-1	Series D0319
Pressure Rating 9137psi	Finish Zinc Nickel		Series Description DIN 2353 Flareless Double Bite Tube Sleeve