

# 9522-P-08

Steel, ISO 1179 BSPP Hex Head Port Plug, 1/2-14 Male BSPP 60° Line/Port

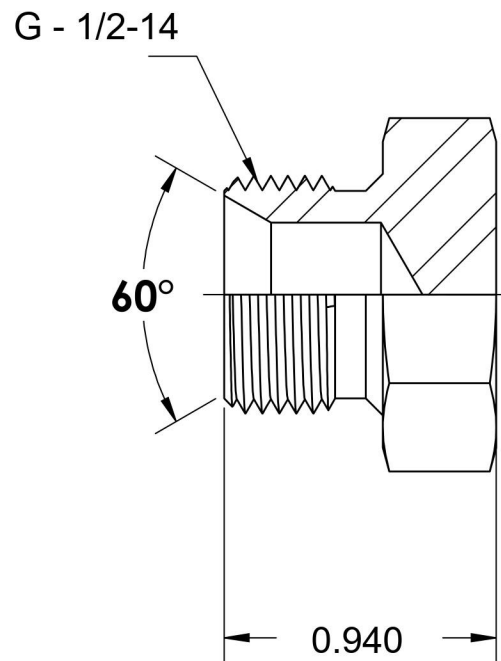
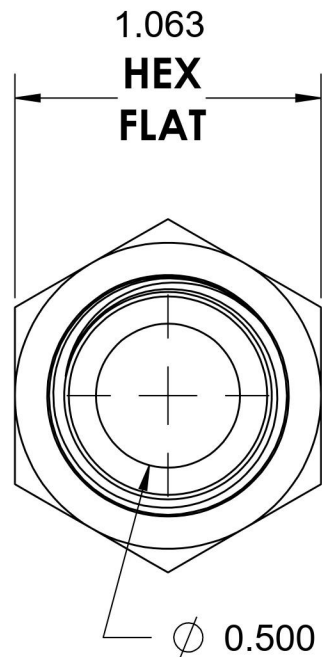
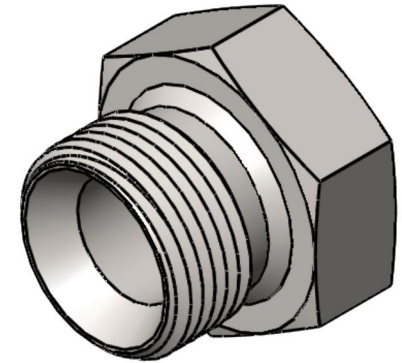

6701 Cochran Road  
Solon, Ohio 44139  
Phone: (440) 248-1880  
Toll Free: 1-888-331-1523

#### Temperature Rating

-65°F to 500°F

#### Pressure Rating

2900 psi

#### Material

C1045/12L14 Steel

#### Finish

Trivalent Zinc

#### Industry Standards

ISO 1179, ASTM B633

#### Series

9522-P

#### Series Description

ISO 1179 BSPP Hex Head Port Plug