

FS6602-06-06-06-SS

Stainless Steel, SAE J1453 O-Ring Face Seal Swivel Run Tee, 3/8" Male ORFS x 3/8" Female ORFS Swivel

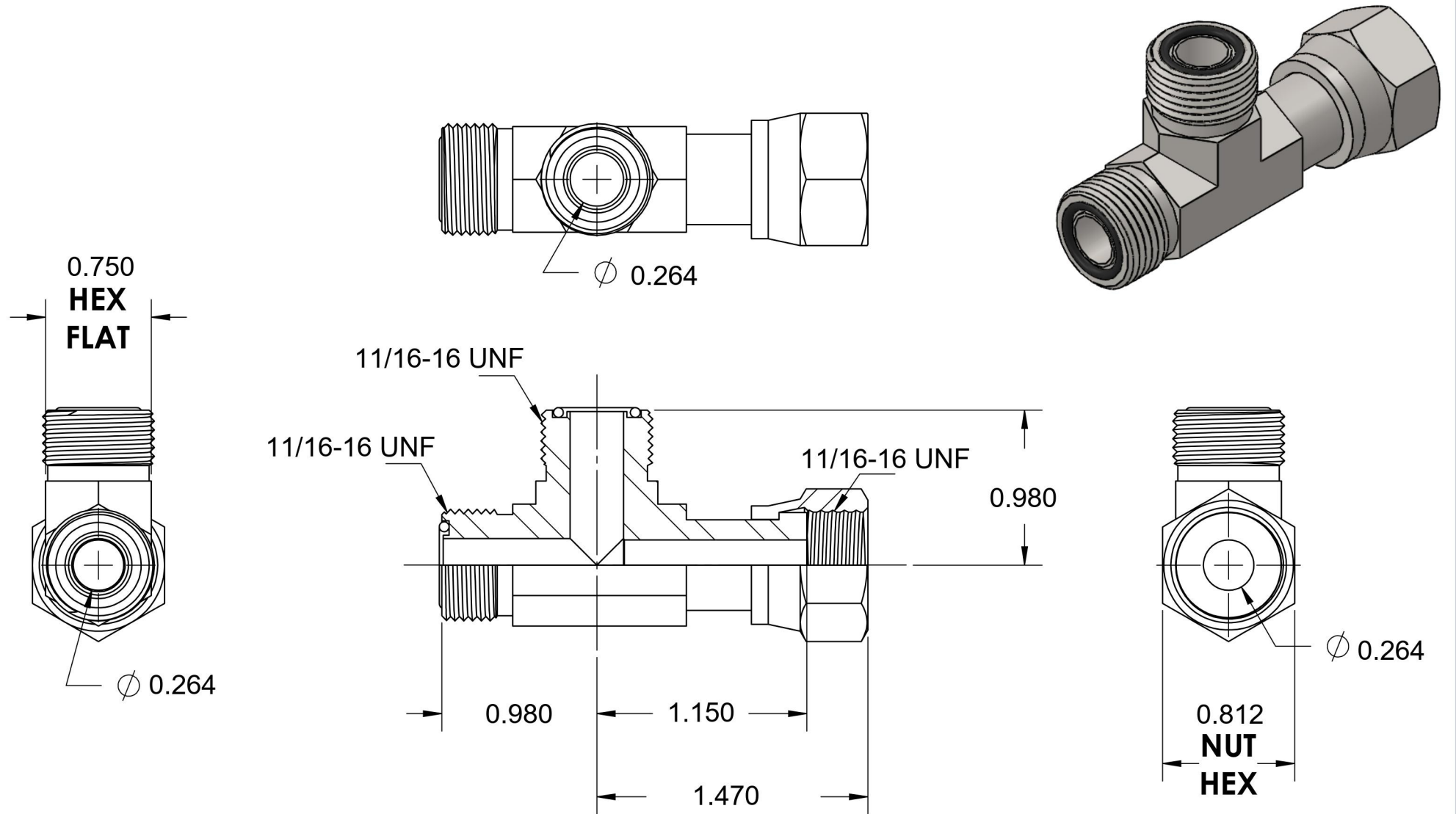

6701 Cochran Road
Solon, Ohio 44139
Phone: (440) 248-1880
Toll Free: 1-888-331-1523

Temperature Rating

-40°F to 250°F

Pressure Rating

9200 psi

Material

316/316L Stainless Steel

Finish

Passivated

Industry Standards

SAE J1453, SAE J515

Series

FS6602-SS

Series Description

SAE J1453 O-Ring Face Seal Swivel Run Tee