

5652-32-32-32-SS

Stainless Steel, SAE J514 Pipe Female Cross, 2" Female NPTF

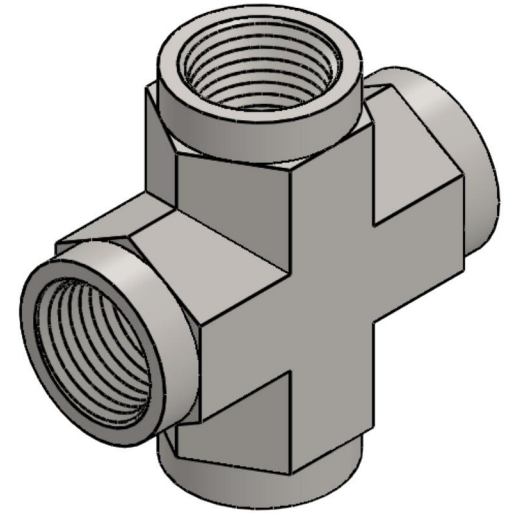
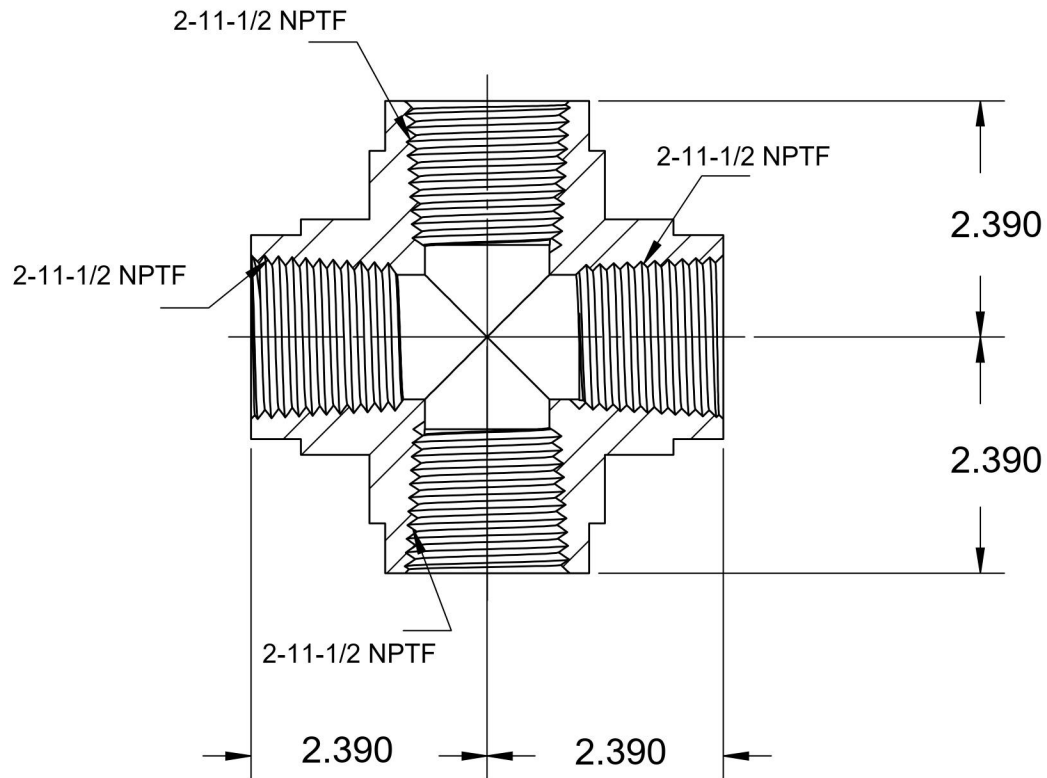
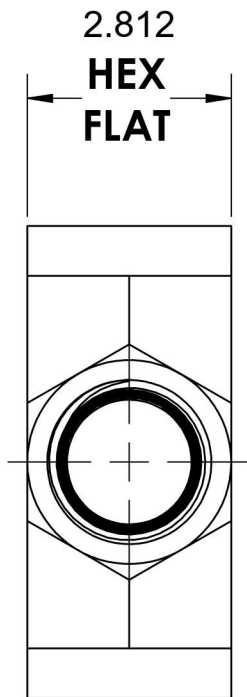

6701 Cochran Road
Solon, Ohio 44139
Phone: (440) 248-1880
Toll Free: 1-888-331-1523

Temperature Rating	Material	Industry Standards	Series
-425°F to 1200°F	316/316L Stainless	SAE J514, SAE J476	5652-FG
Pressure Rating	Finish		Series Description
1500psi	Passivation		SAE J514 Pipe Female Cross