

6802-08-10-NWO-FG-VITON

Steel, SAE J514 37° Flare 45° Adjustable Port Elbow, 1/2" Male JIC x 7/8-14 Male Adjustable ORB, FKM Seal

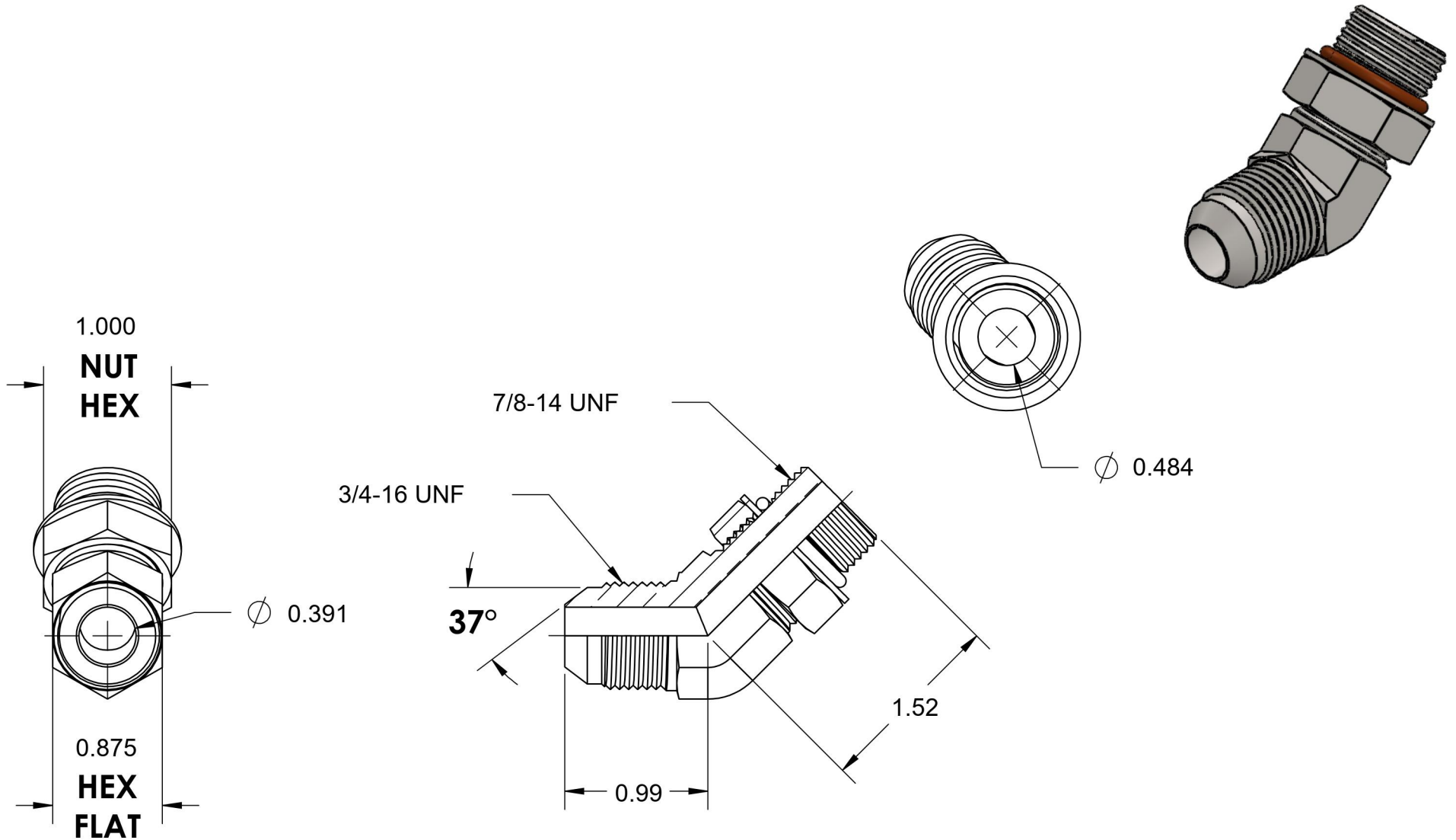

6701 Cochran Road
Solon, Ohio 44139
Phone: (440) 248-1880
Toll Free: 1-888-331-1523

Temperature Rating -15°F to 400°F	Material C1045 Steel	Industry Standards SAE J514, SAE J1926-3 SAE J515, ASTM B633	Series 6802-NWO-FG-VITON
Pressure Rating 5000 psi	Finish Trivalent Zinc		Series Description SAE J514 37° Flare 45° Adjustable Port Elbow